

+10
 mois / mesi / mēsicū / meseceŭ
 months / mēsi / mēsiacov / mjeseci
 Monate / māneder / mēsiecy / mjeseč
 maanden / kuukauden / mēseca / mjesacov
 meses / māneder / lūni / mēsiacov / kuu
 meses / hōnapban / mjēc / mēsiacov / mēnesiŭ
 شهر / mjēc / mēsiacov / mēnesiŭ

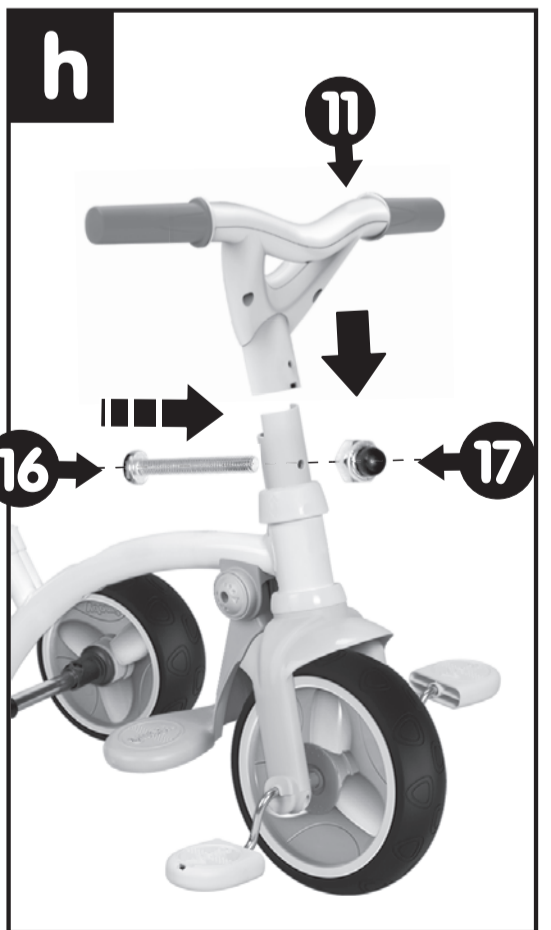

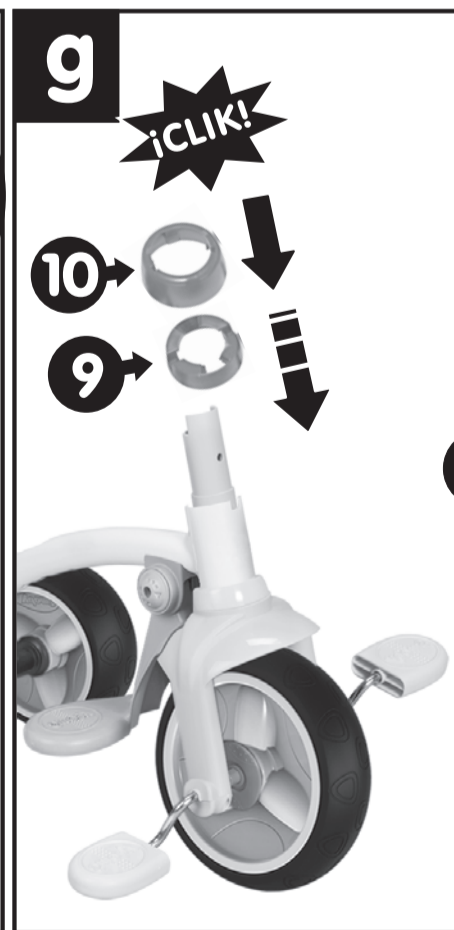
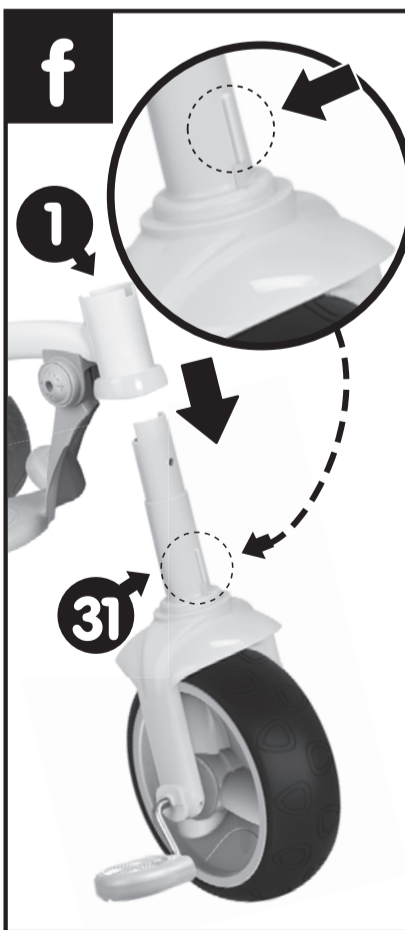
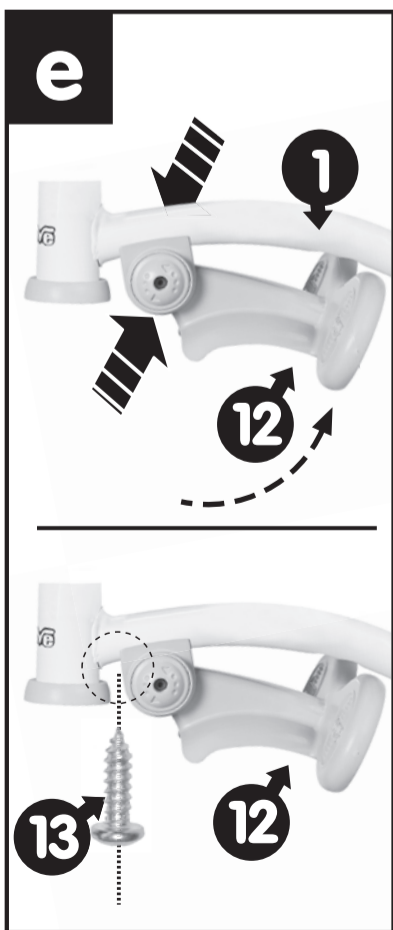
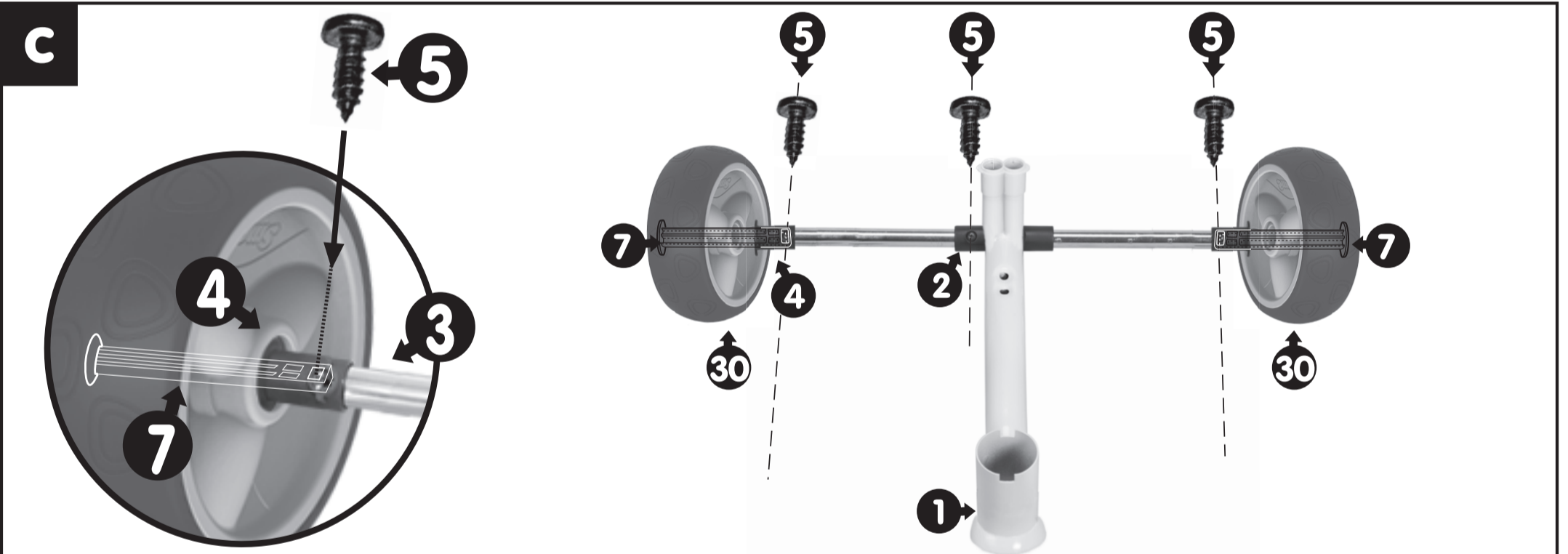
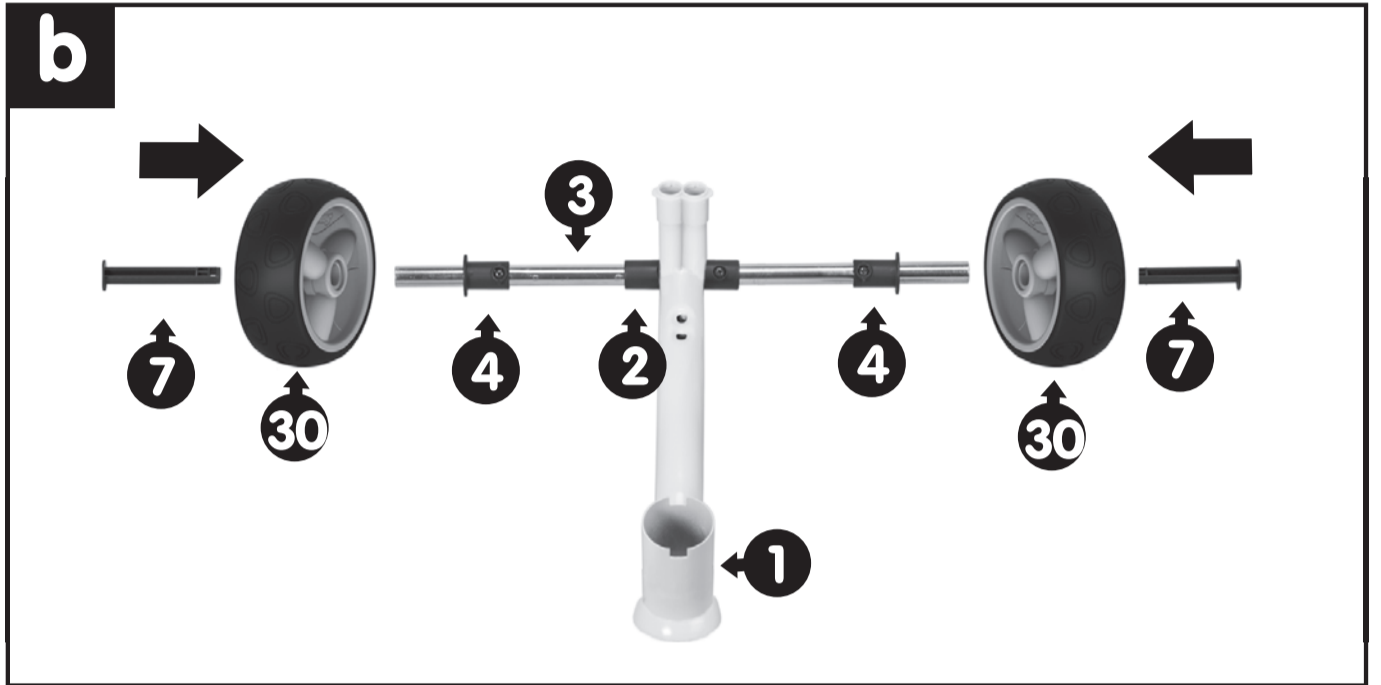
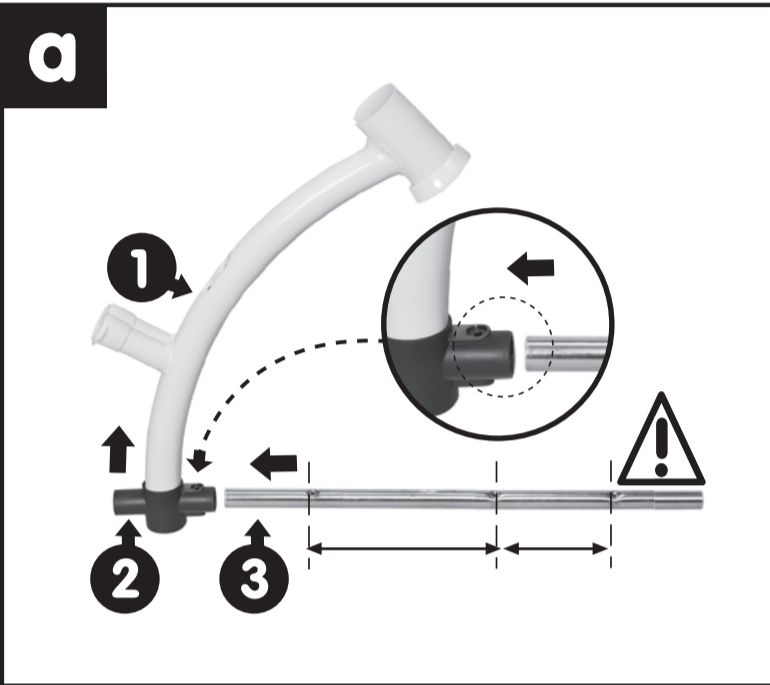
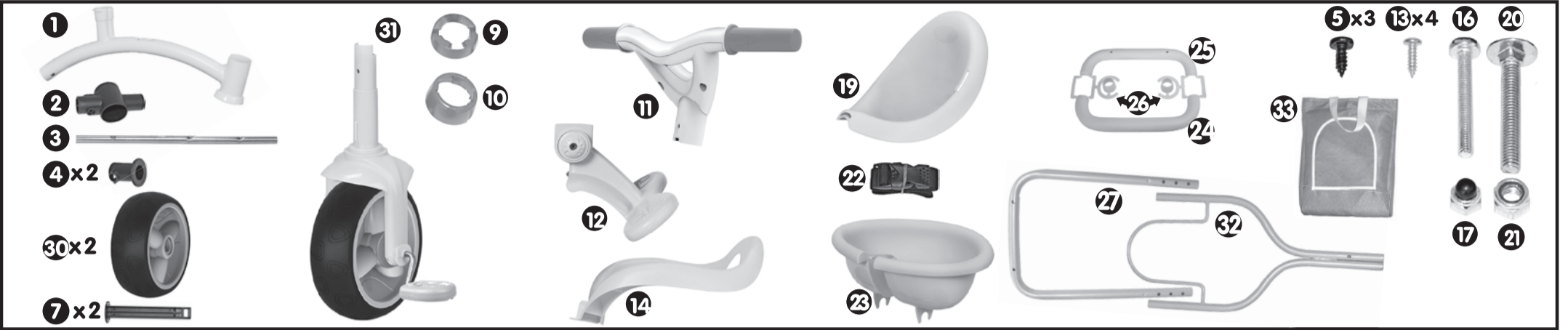
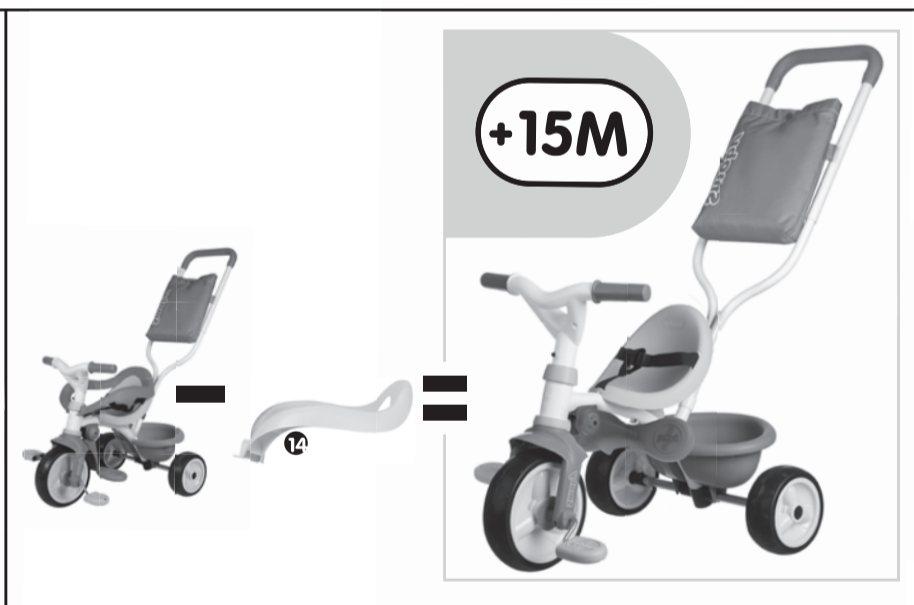
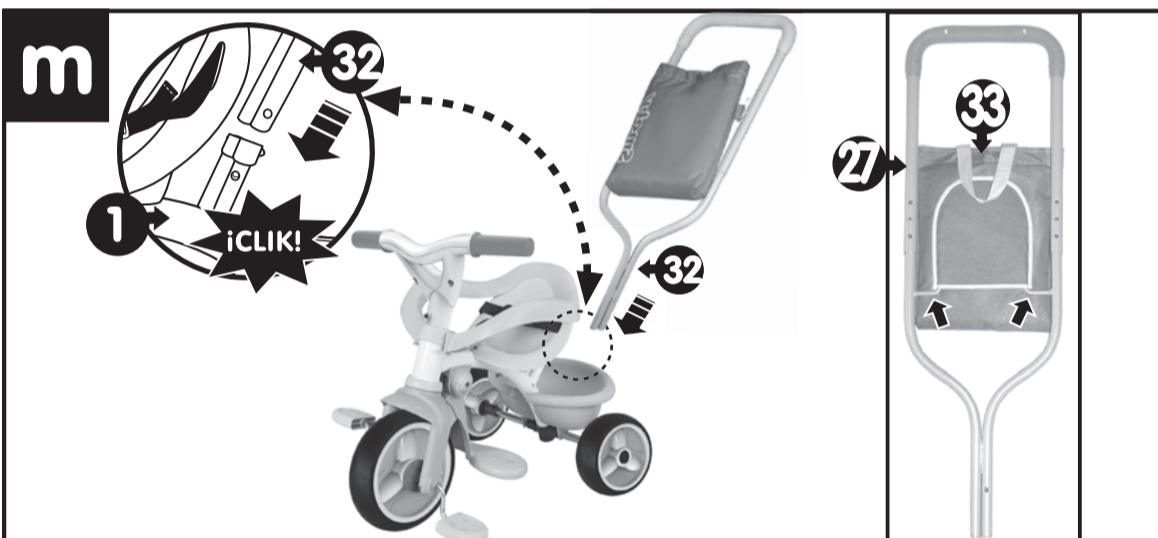
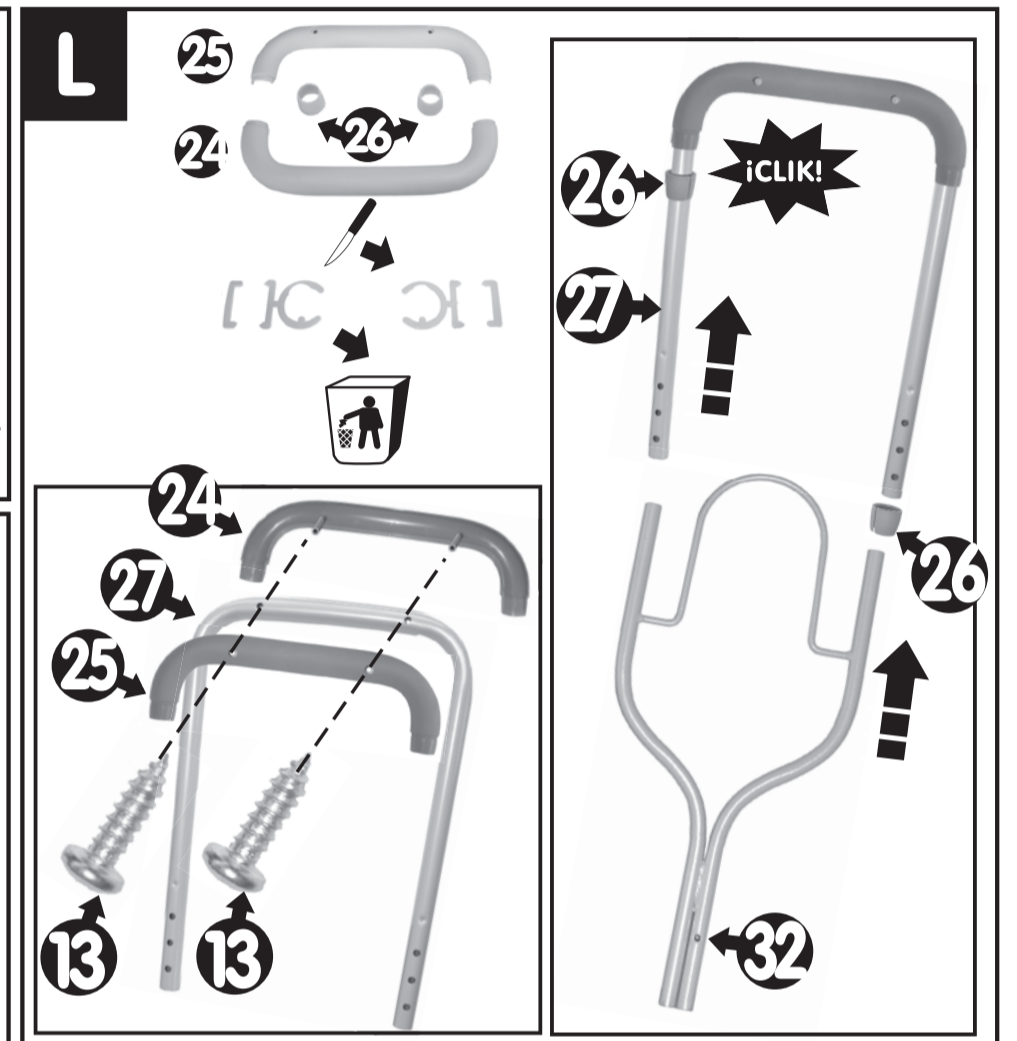
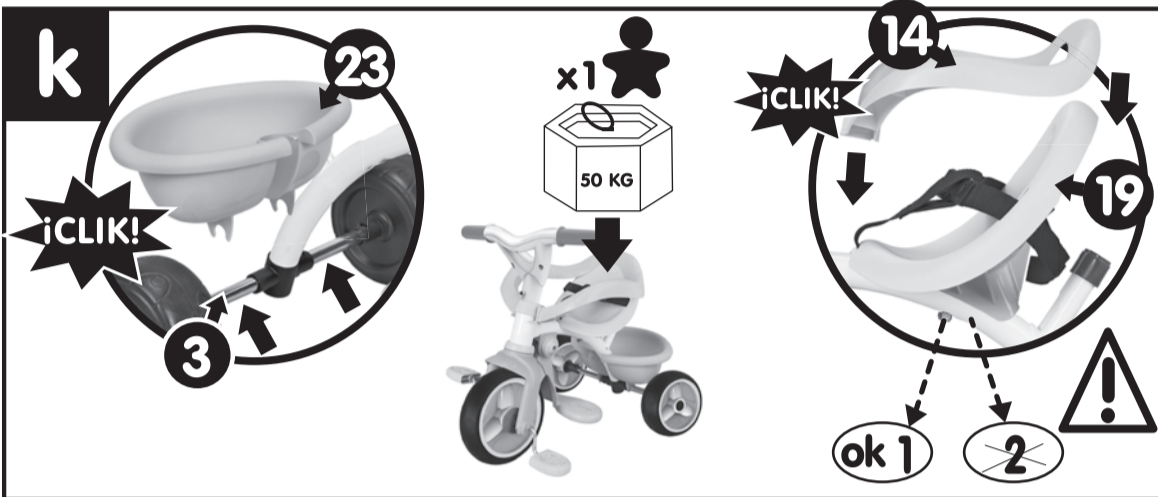
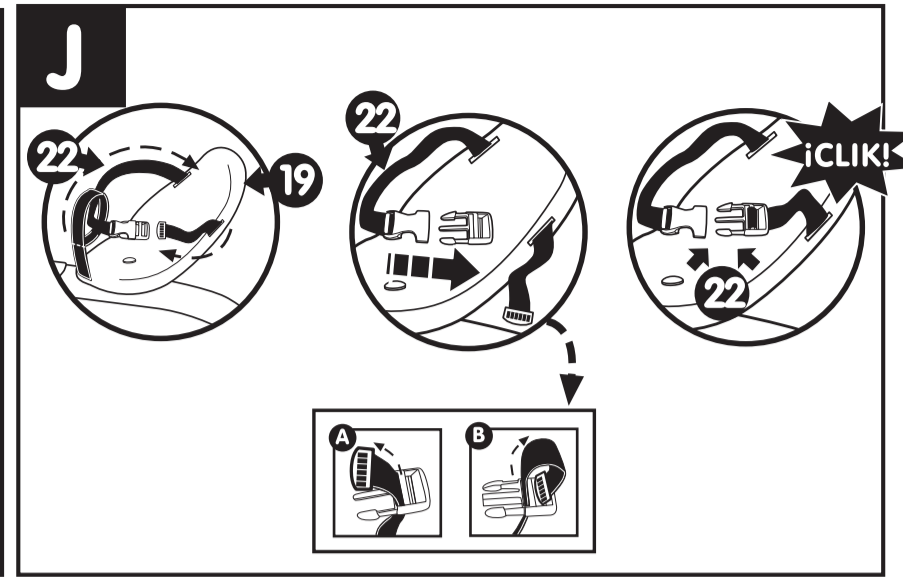
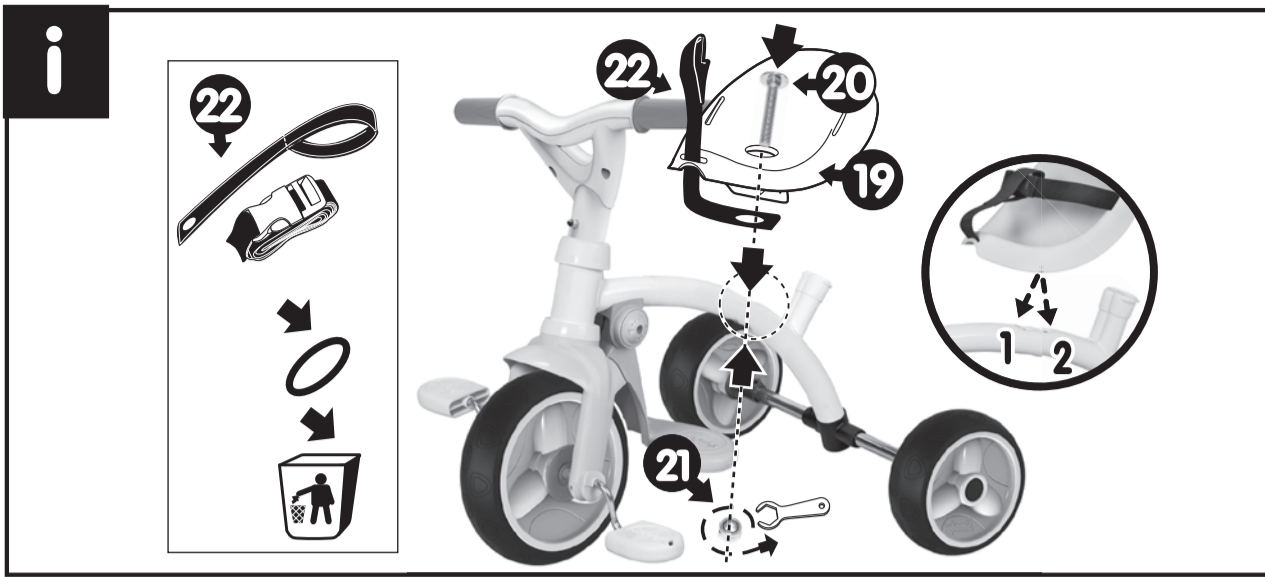

BE MOVE COMFORT **SMOBY TOYS S.A.S.**
 Service après vente / After sales service : www.smoby.fr
 Le Bourg Dessus - 39170 Lavans-lès-Saint-Claude / France.

Assistance consommateurs à nous retourner en cas de problèmes / Consumer assistance: for any problems, return this card /
 Verbraucher-Info: Für weitere Auskünfte, senden Sie diese Karte bitte an / Klantenservice: voor inlichtingen, deze kaart naar ons terugsturen/
 Atención al consumidor : para cualquier información, enviar esta tarjeta. / Assistenza per il consumatore : per informazioni, rispedire la presente cartolina.

Description du motif de la réclamation / Cause for complaint / Grund der Beanstandung / Omschrijving van de reden van de klacht / Detalle el motivo de su reclamación / Descizione del motivo del reclamo:

Manquant / Missing / Fehlende Teile / Tekort / Faltante / Mancante.
 Cassé / Broken / Gebrochen / Gebroken / Rotura / Rotto.
 Commentaires / Comments / Bemerkung / Opmerkingen / Comentarios / Commenti.

N°: N°: N°: N°: N°: N°: N°:
 Qté: Qté: Qté: Qté: Qté: Qté: Qté:

Ref: _____
 Couleurs/Colors: _____
 N° Notice / IS Number: 03347X0/5

NOM / NAME: _____
 PRENOM / SURNAME: _____
 RUE / STREET: _____
 VILLE / TOWN: _____
 CODE POSTAL / POSTAL CODE: _____
 PAYS / COUNTRY: _____
 N°TEL: _____
 EMAIL: _____

