

playmobil®

9243



# WARNING: CHOKING HAZARD

Contains a small ball and small parts.  
Not for children under 3 years.

"Ne concerne que les USA"

Wichtige Unterlagen, bitte sorgfältig aufbewahren!  
Important: Please keep these instructions for future reference!  
Documents importants, à conserver soigneusement!  
Belangrijke documenten, bewaar deze zorgvuldig!





DreamWorks Dragons © 2017 DreamWorks Animation LLC. All Rights Reserved.

1

① 

② 

③   
+ 1x Micro 1,5V  
R03 • LR03 • AAA -

④ **An / Aus**  
**On / Off**  
**Marche / Arrêt**  

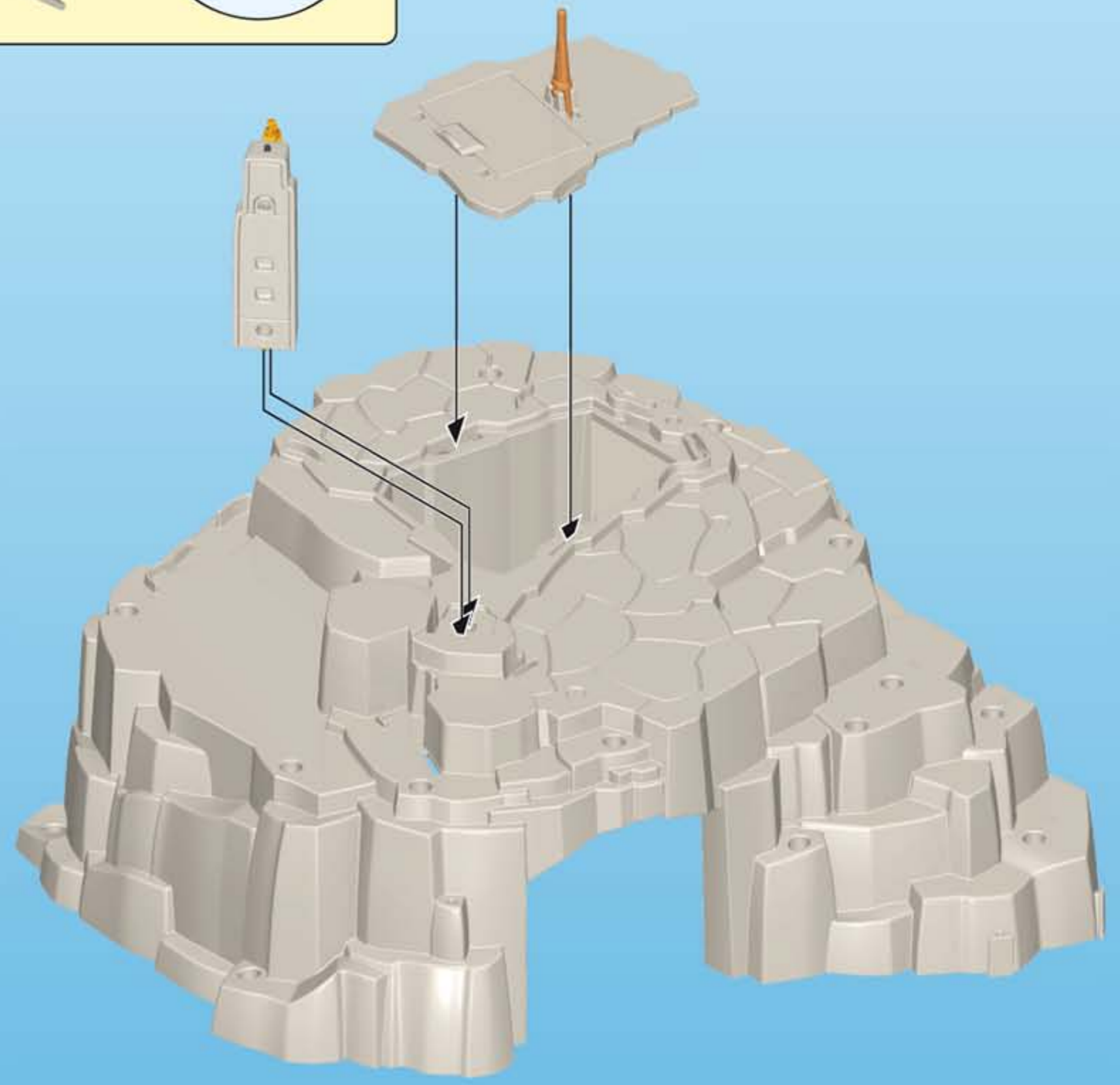
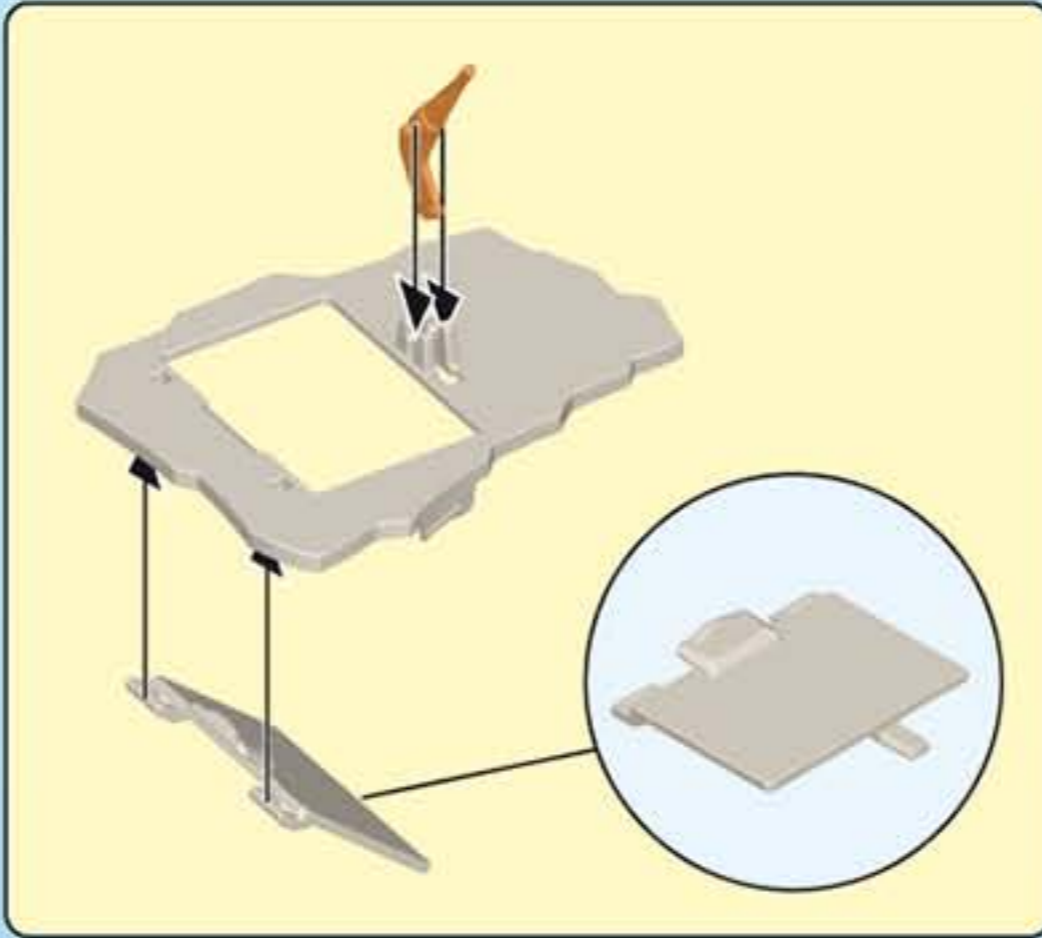

2



3

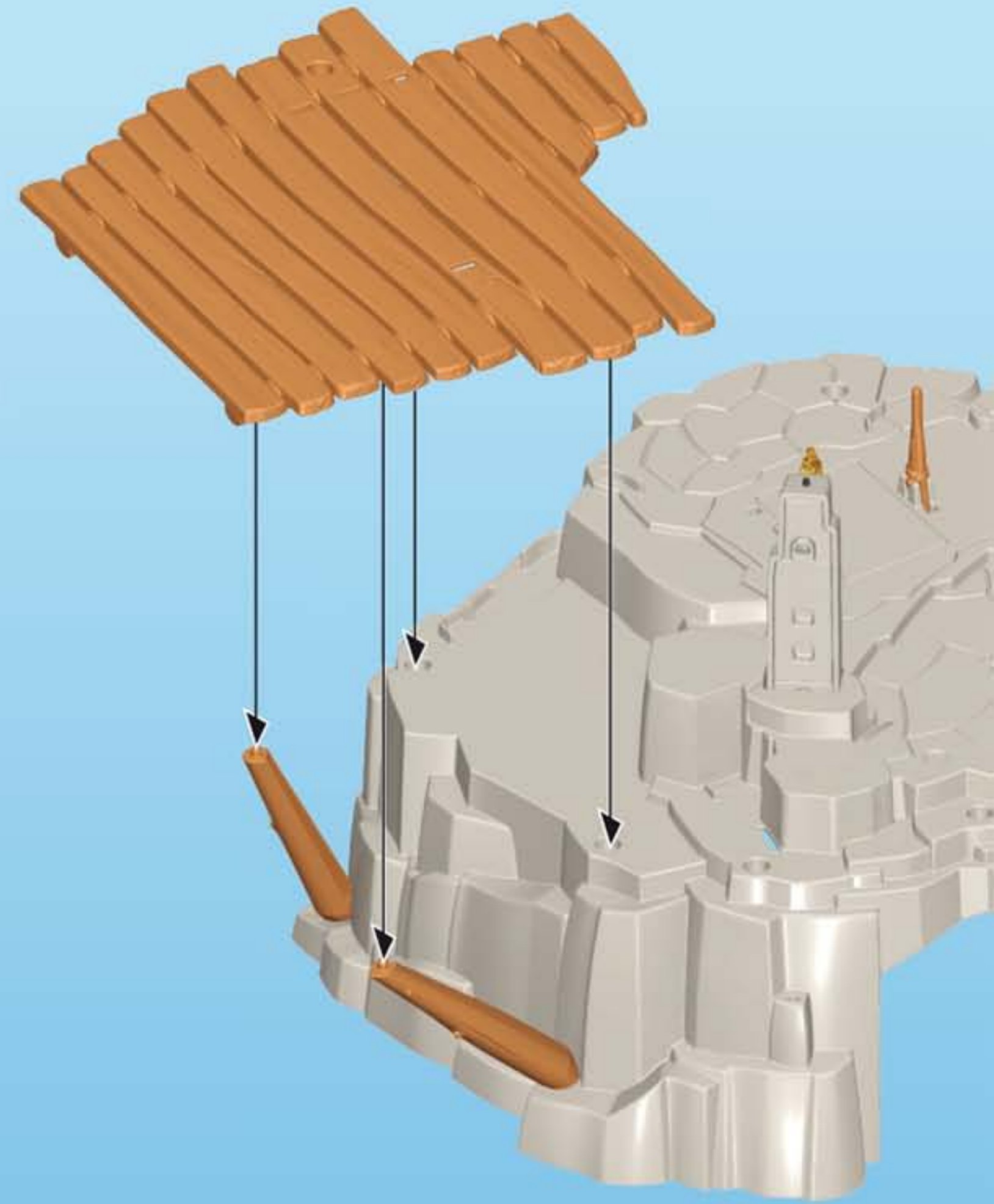

4

1



2

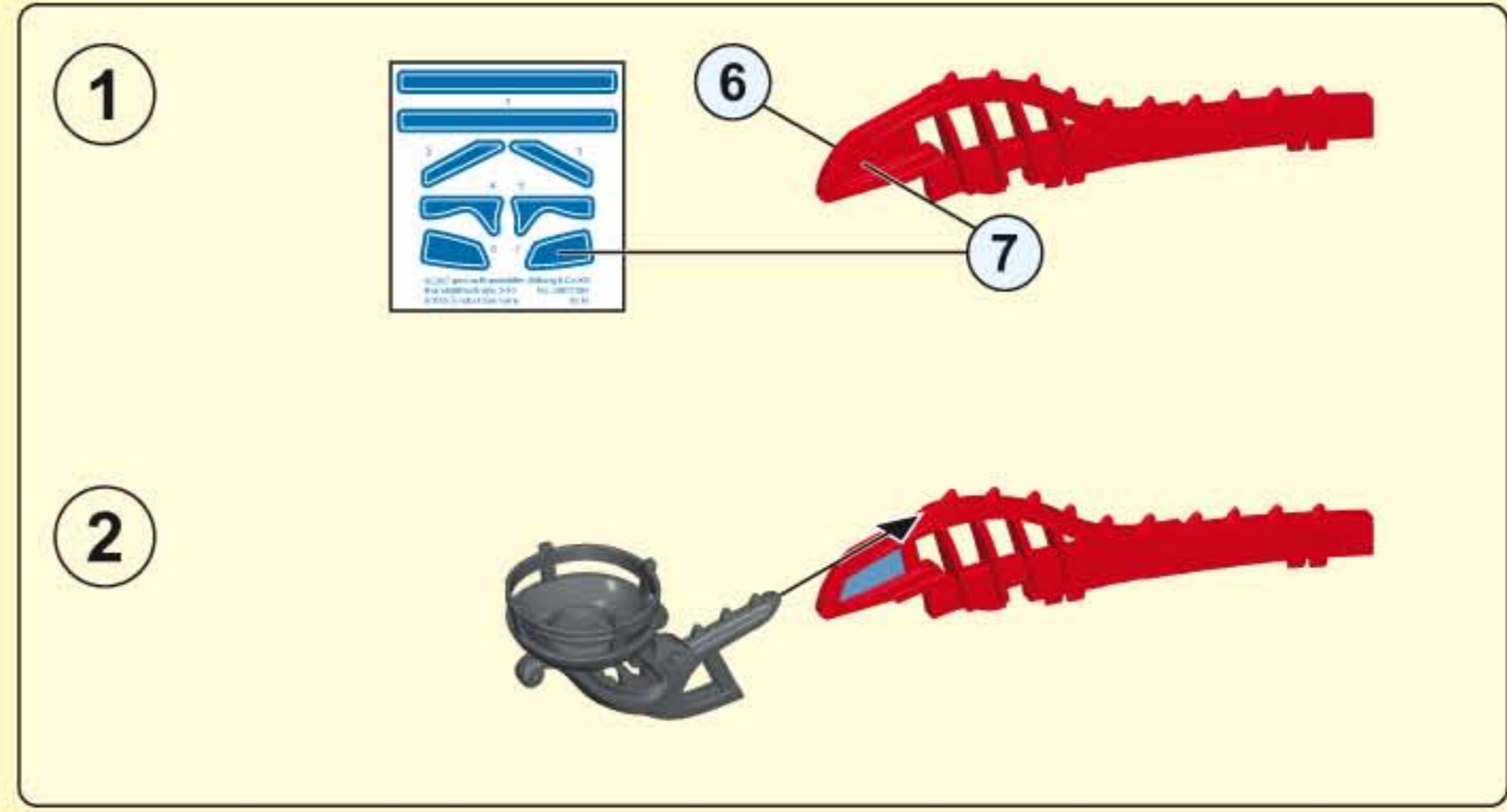

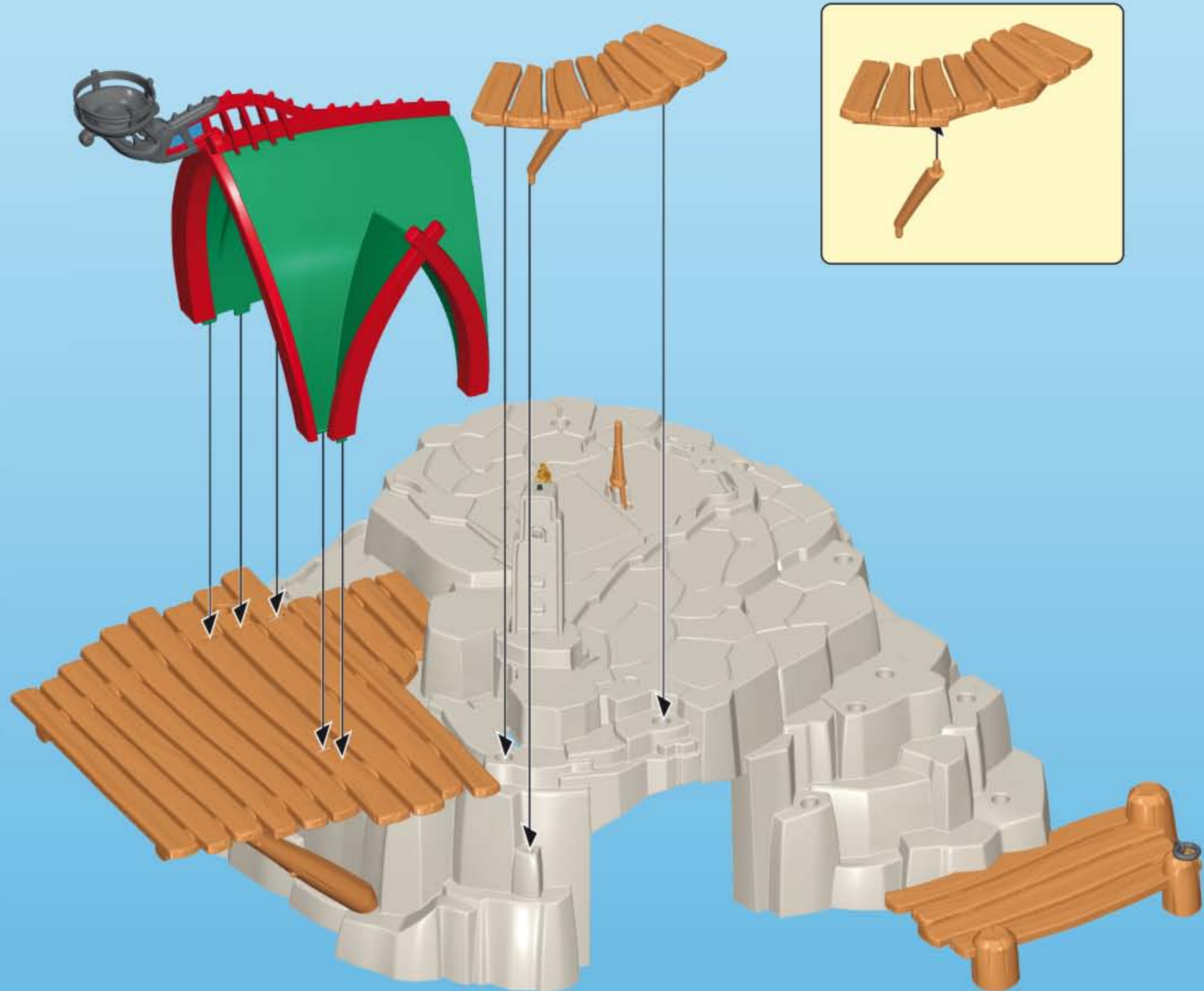

5

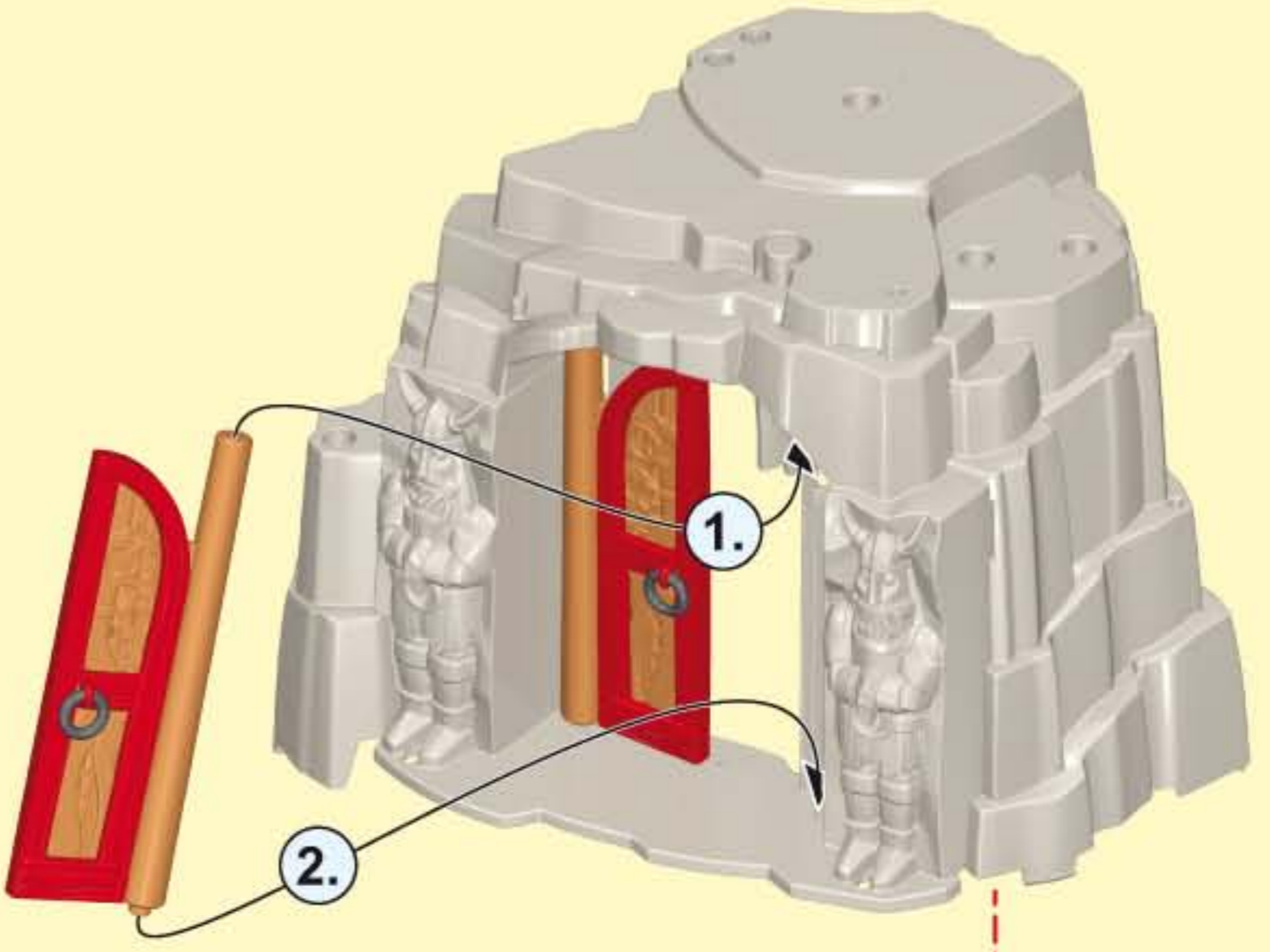
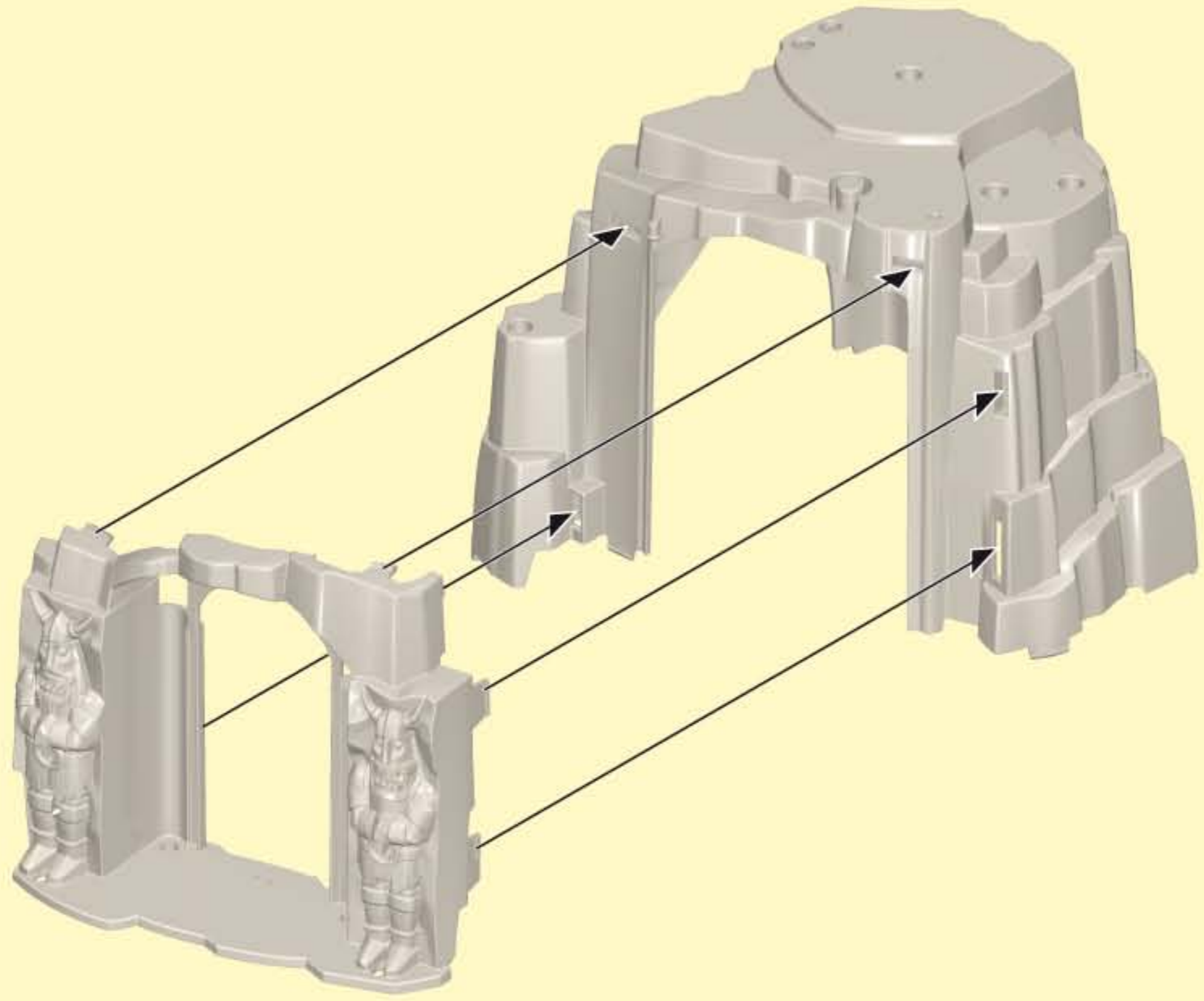
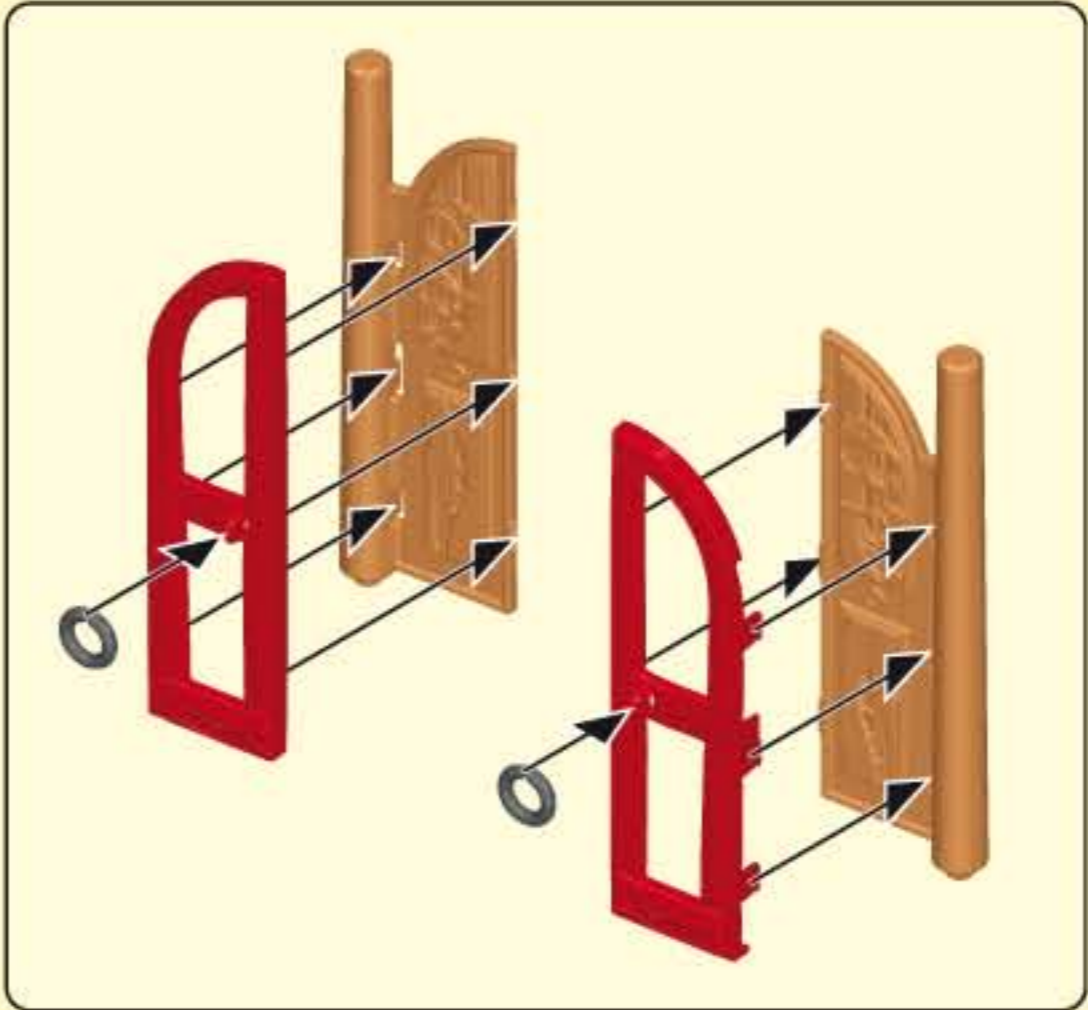

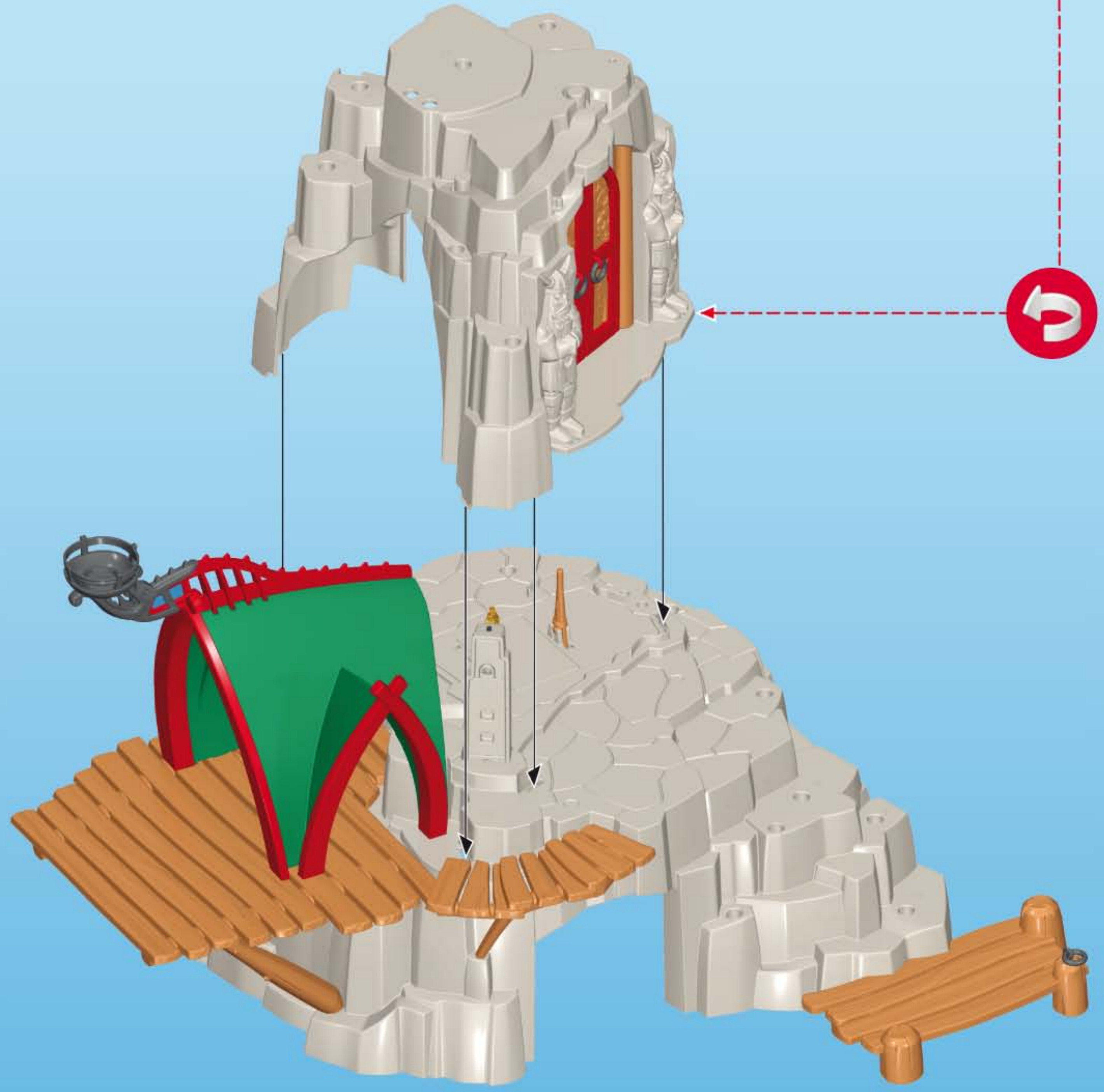

6

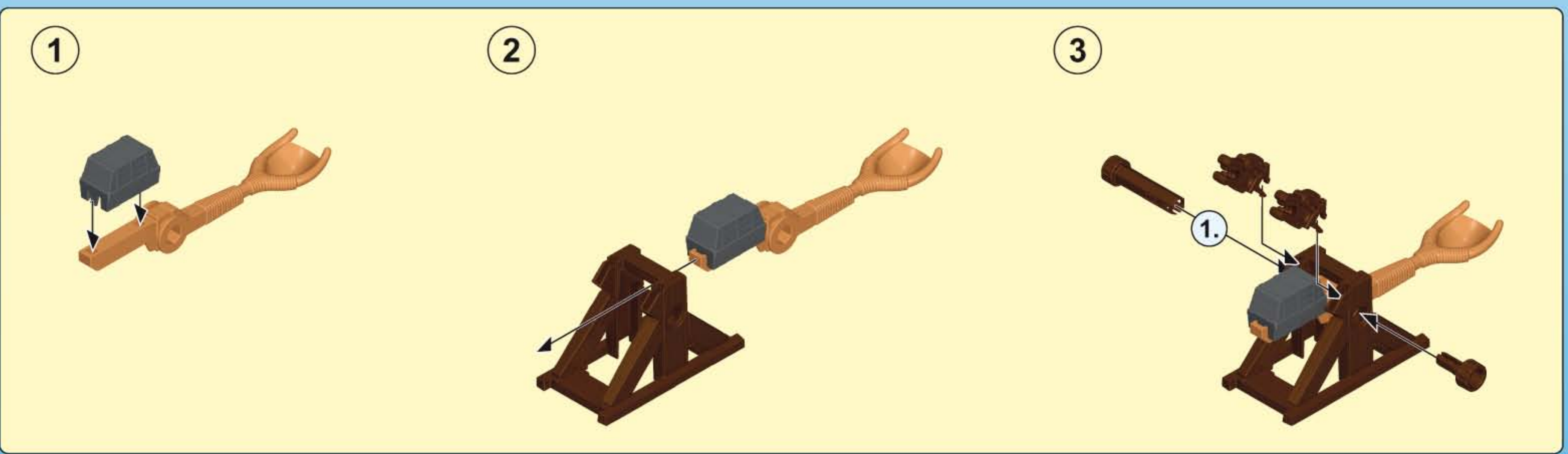
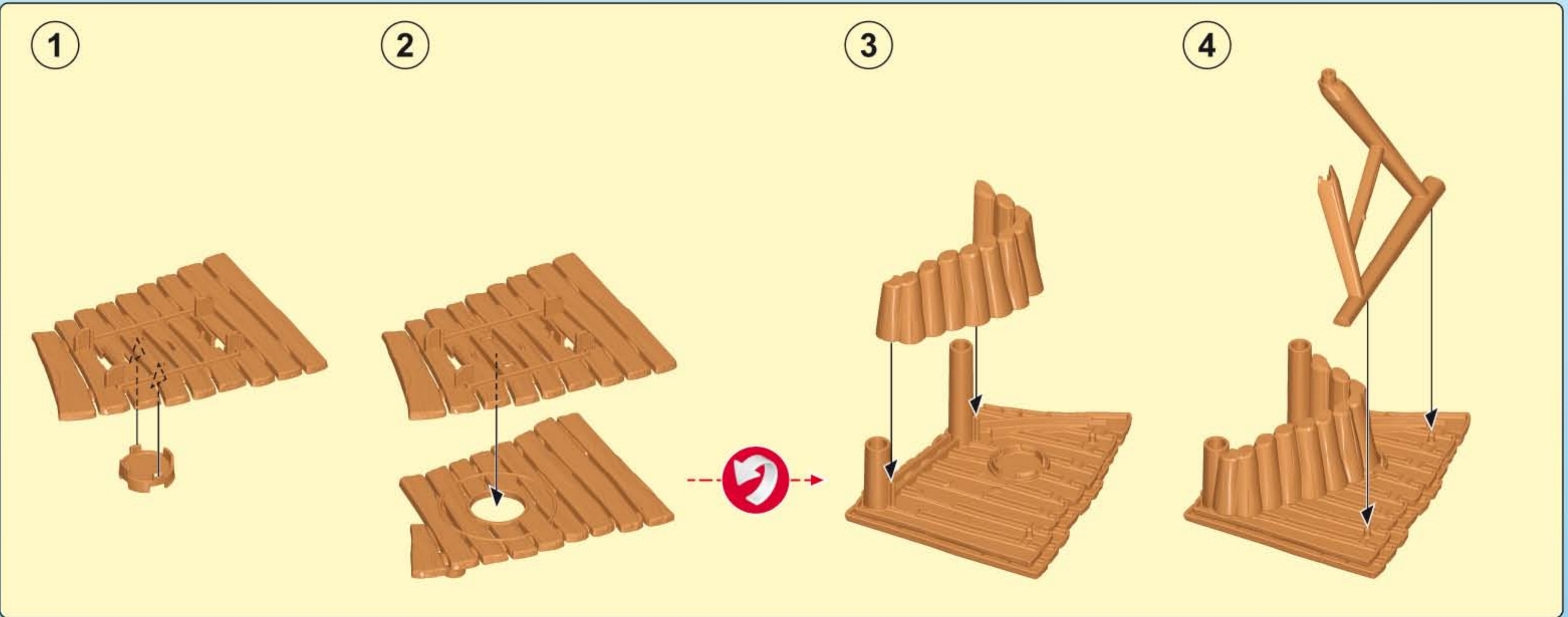



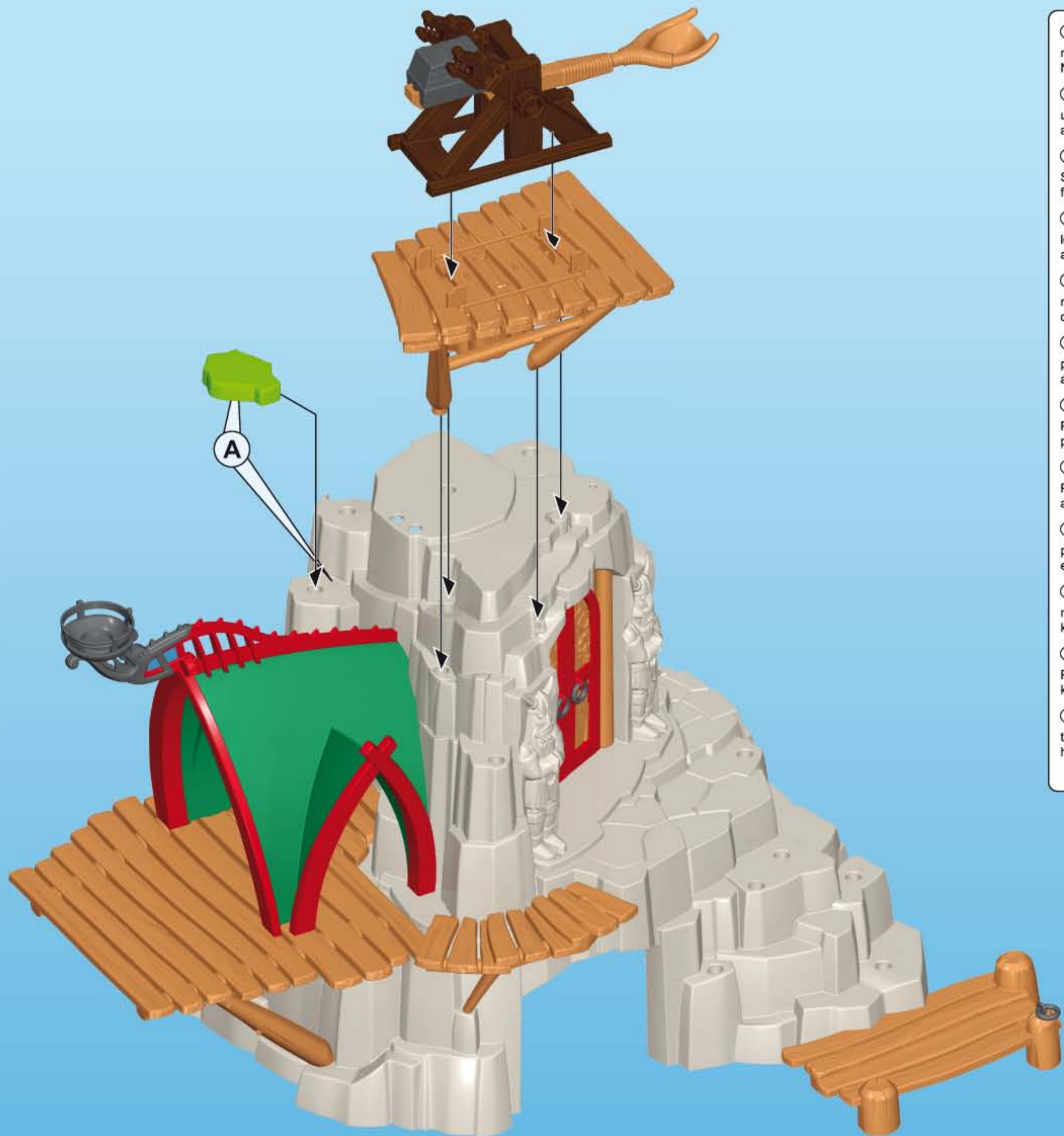

**(D) (A) (CH) (L) (B) ACHTUNG!** Nur mitgelieferte PLAYMOBIL Geschosse verwenden. Nicht auf Augen oder Gesicht zielen.

**(USA) (GB) (CDN) (M) (IRL) WARNING!** Only use the PLAYMOBIL projectiles supplied. Do not aim at eyes or face.

**(F) (CDN) (B) (L) (CH) ATTENTION!** Seulement utiliser les projectiles PLAYMOBIL fournis. Ne pas viser les yeux ou le visage.

**(E) (MEX) ¡ADVERTENCIA!** Utiliza únicamente los proyectiles PLAYMOBIL suministrados. No apuntar a los ojos ni a la cara.

**(NL) (B) WAARSCHUWING!** Uitsluitend meegeleverde PLAYMOBIL delen gebruiken. Niet op ogen of gezicht richten.

**(I) (CH) AVVERTENZA!** Usare soltanto i proiettili PLAYMOBIL in dotazione. Non mirare agli occhi o al viso.

**(P) ATENÇÃO!** Usar apenas os projécteis PLAYMOBIL juntamente fornecidos. Não apontar para os olhos ou face.

**(DK) ADVARSEL!** Anvend kun de medfølgende PLAYMOBIL projektiler. Sigt ikke mod øjne eller ansigt.

**(N) ADVARSEL!** Benytt kun PLAYMOBIL prosjektil som leveres med. Sikt ikke på ansikt eller øyne.

**(S) (FIN) VARNING!** Använd endast medlevererade PLAYMOBIL-skott. Ei saa kohdistaa suoraan silmiin tai kasvoihin.

**(FIN) VAROITUS!** Käytä vain mukana toimitettuja PLAYMOBIL-ammuksia. Älä tähtää päin silmiä tai kasvoja.

**(H) FIGYELMEZTETÉS.** Csak a csomagban található PLAYMOBIL lövedékeket szabad használni. Tilos szemre vagy arcra célozni.

**(CZ) UPOZORNĚNÍ!** Používejte pouze střely PLAYMOBIL, které jsou součástí dodávky. Nemířte na oči nebo na obličej!

**(EST) HOIATUS!** Kasutage ainult kaasaantud PLAYMOBIL'i laskemoona. Ära sihi silmadesse ega näkku.

**(LV) BRĪDINĀJUMS!** Izmantot tikai PLAYMOBIL piegādes komplektā iekļautos šāviņus. Nevērst pret acīm vai seju.

**(LT) ĮSPĖJIMAS!** Naudokite tik pridedamus PLAYMOBIL šaudmenis. Netaikyti į akis arba veidą.

**(SLO) OPOZORILO!** Uporabljajte le priložene PLAYMOBIL-ove krogle. Ne merite v oči ali obraz.

**(SK) UPOZORNENIE!** Používajte len náboje dodávané spolu so sadou PLAYMOBIL. Nemieriť do očí alebo do tváre.

**(PL) OSTRZEŻENIE!** Stosować tylko załączone PLAYMOBIL - kule / pociski. Nie celować w oczy i twarz.

**(TR) (CY) ΔΙΚΚΑΤ!** Sadece birlikte verilen PLAYMOBIL mermileri kullanınız. Göze veya yüze doğru tutmayınız.

**(GR) (CY) Προειδοποίηση!** Να χρησιμοποιούνται αποκλειστικά τα βλήματα της PLAYMOBIL που περιέχονται στη συσκευασία. Μη μην γίνεται στόχευση στα μάτια ή στο πρόσωπο.

**(RO) AVERTISMENT!** Se folosesc doar proiectilele incluse PLAYMOBIL. Nu se țintește în ochi sau în față.

**(BG) Внимание!** Използвайте само приложени PLAYMOBIL снаряди. Не насочвайте към очите и лицето.

**(HR) UPOZORENJE!** Upotrijebiti samo od strane PLAYMOBIL-a isporučene projekte. Ne ciljati u oči ili lice.



**(CN) 警告!** 仅能用PLAYMOBIL的炮弹, 禁止瞄准眼睛或脸, 请勿瞄准眼睛或脸。

(说明书上含有重要信息, 请保留备用)

7

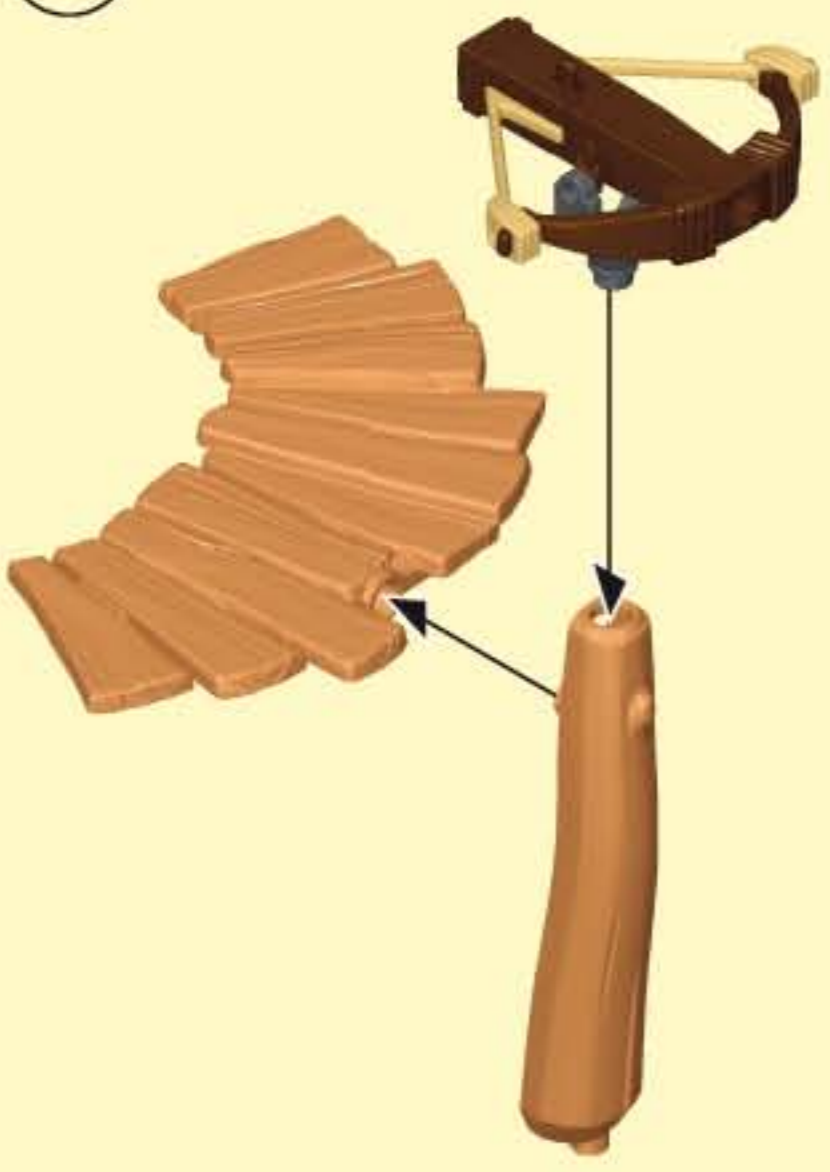

8

- 1 
- 2 
- 3 

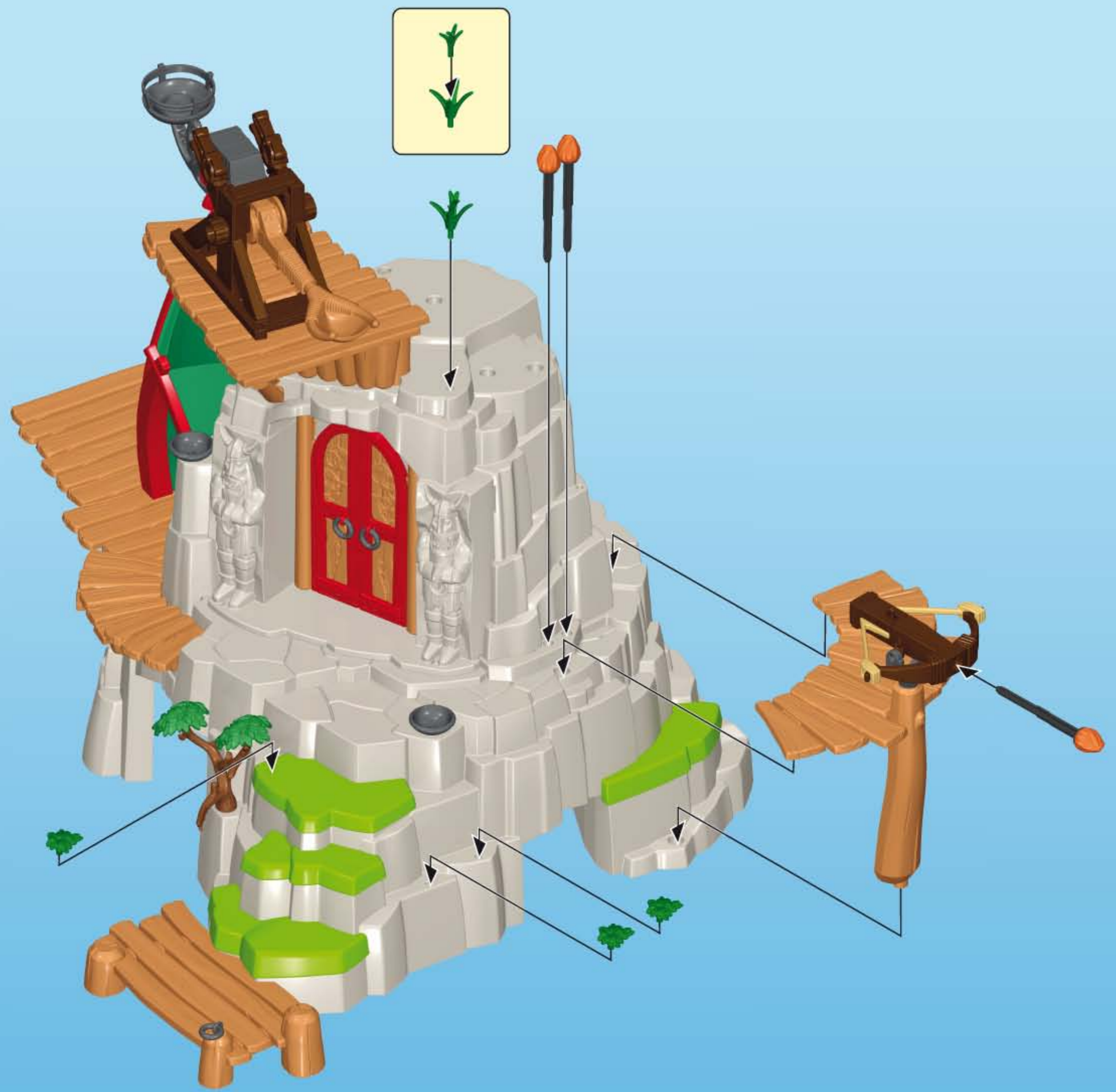

1

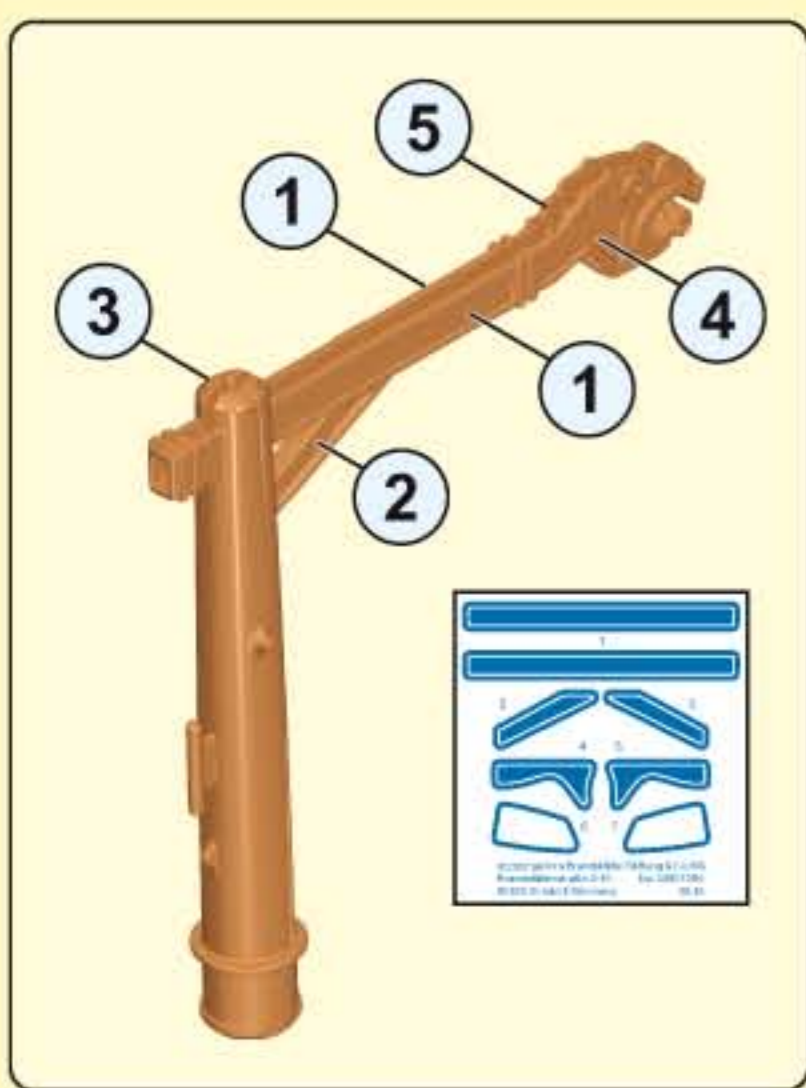

2

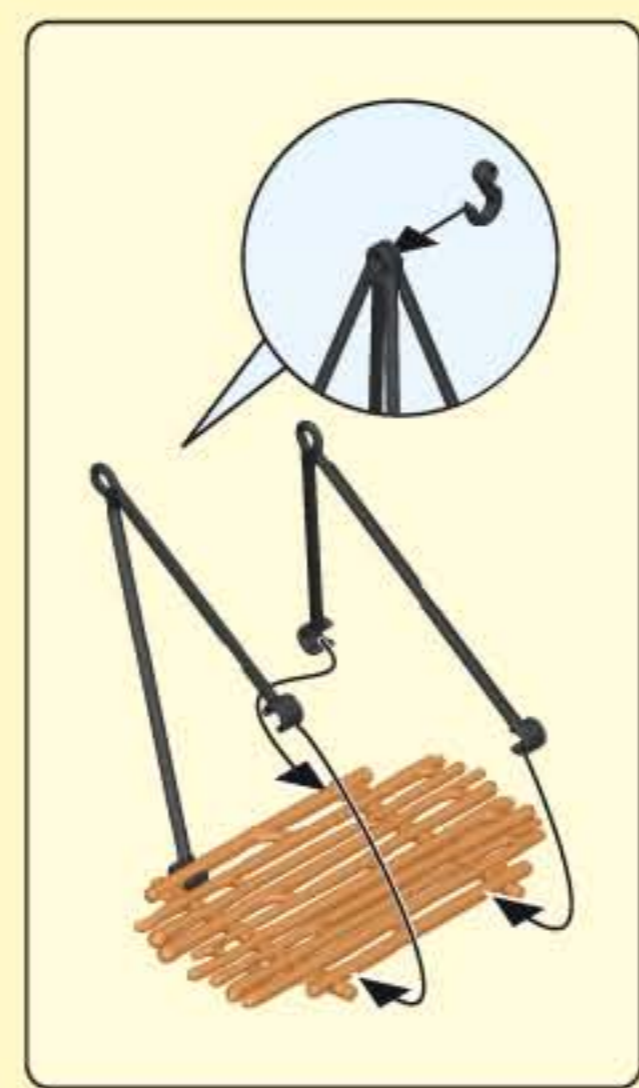

3

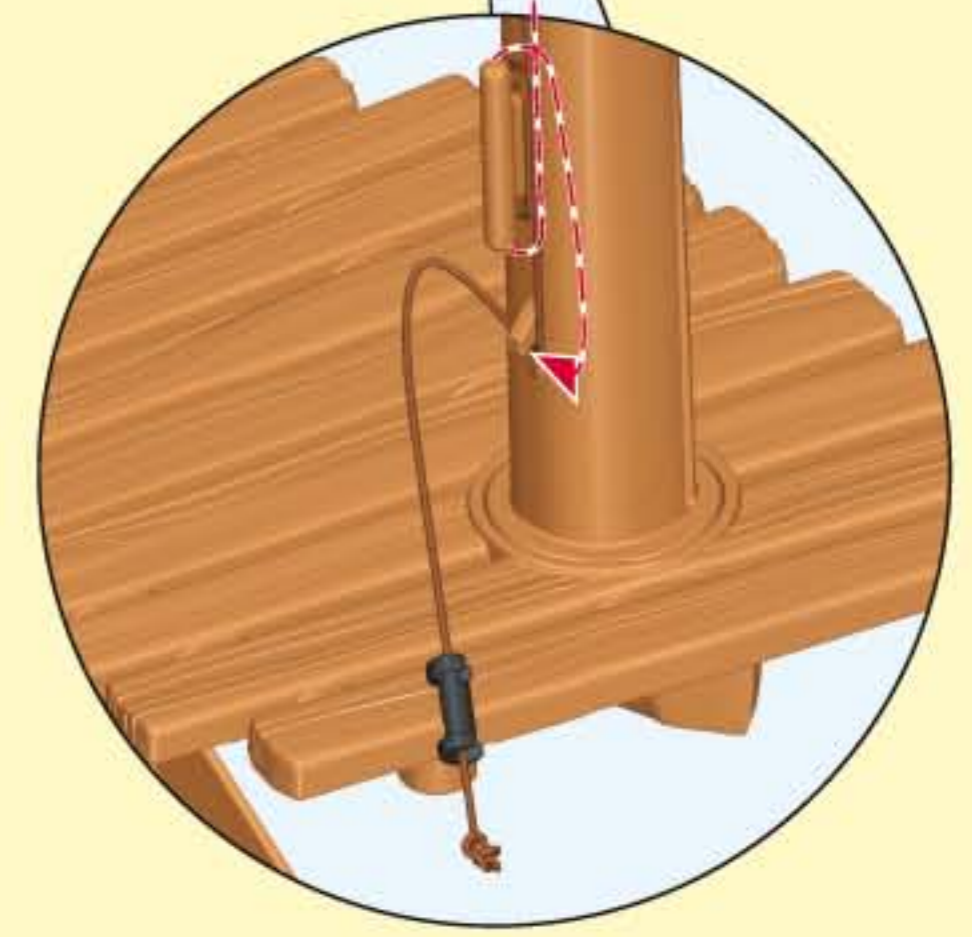
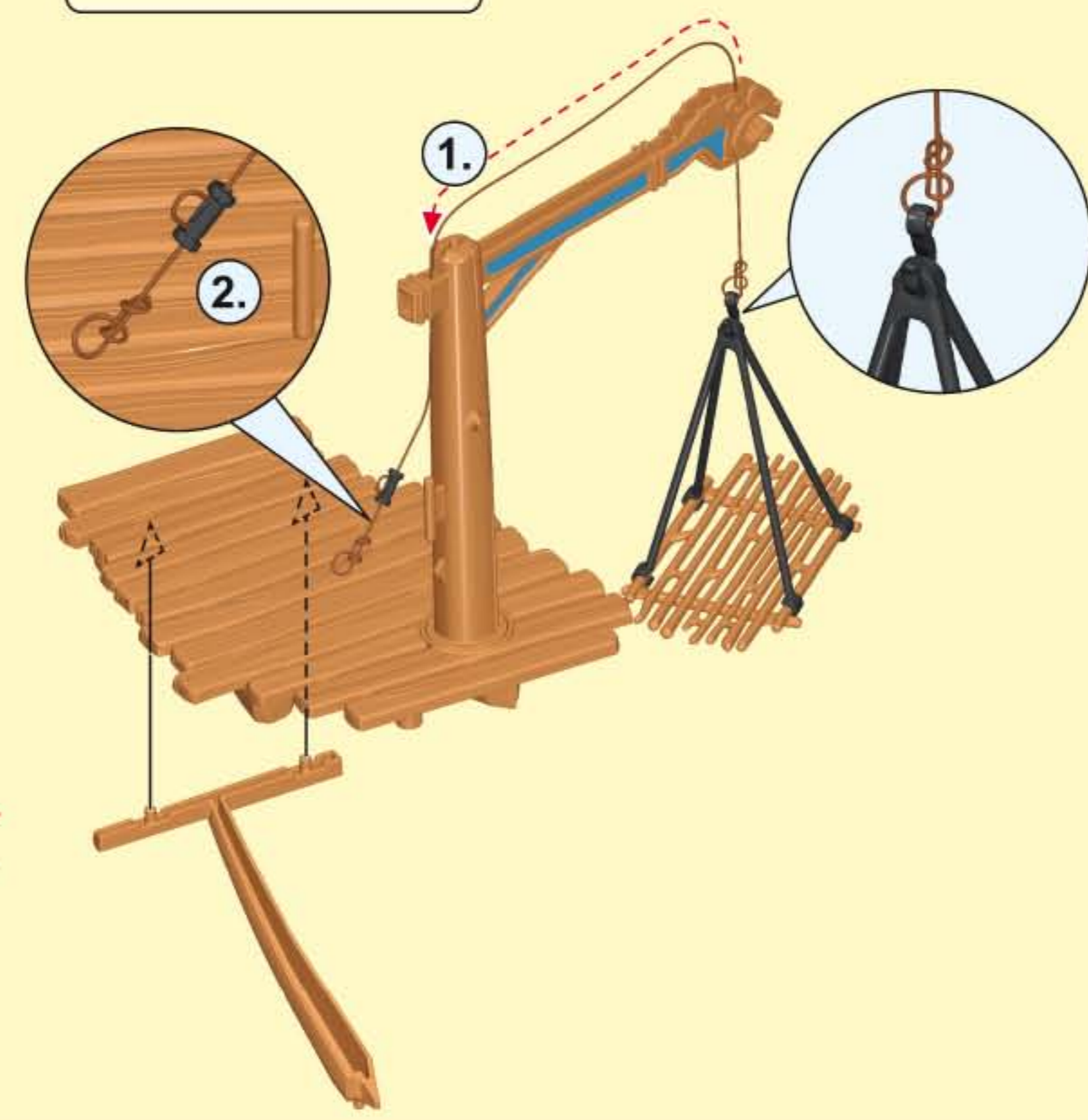

9



10



11

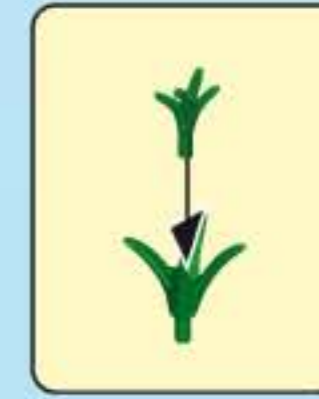

1

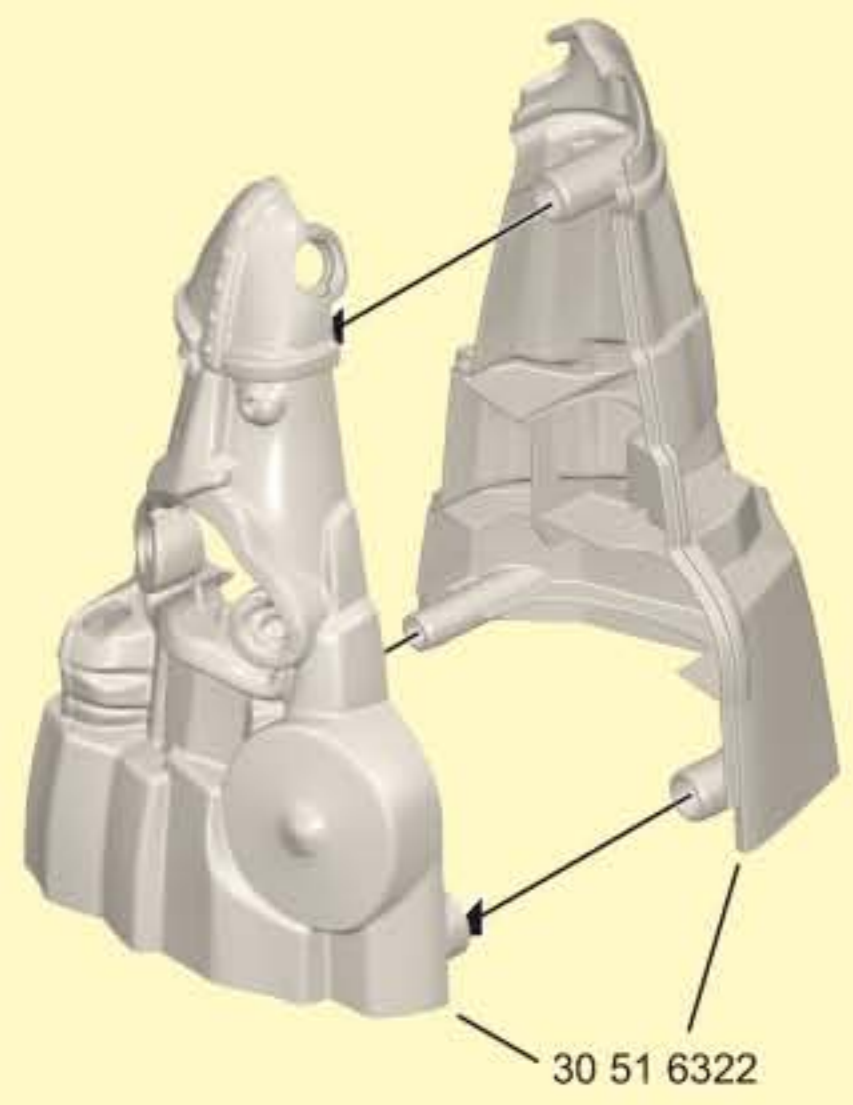

2

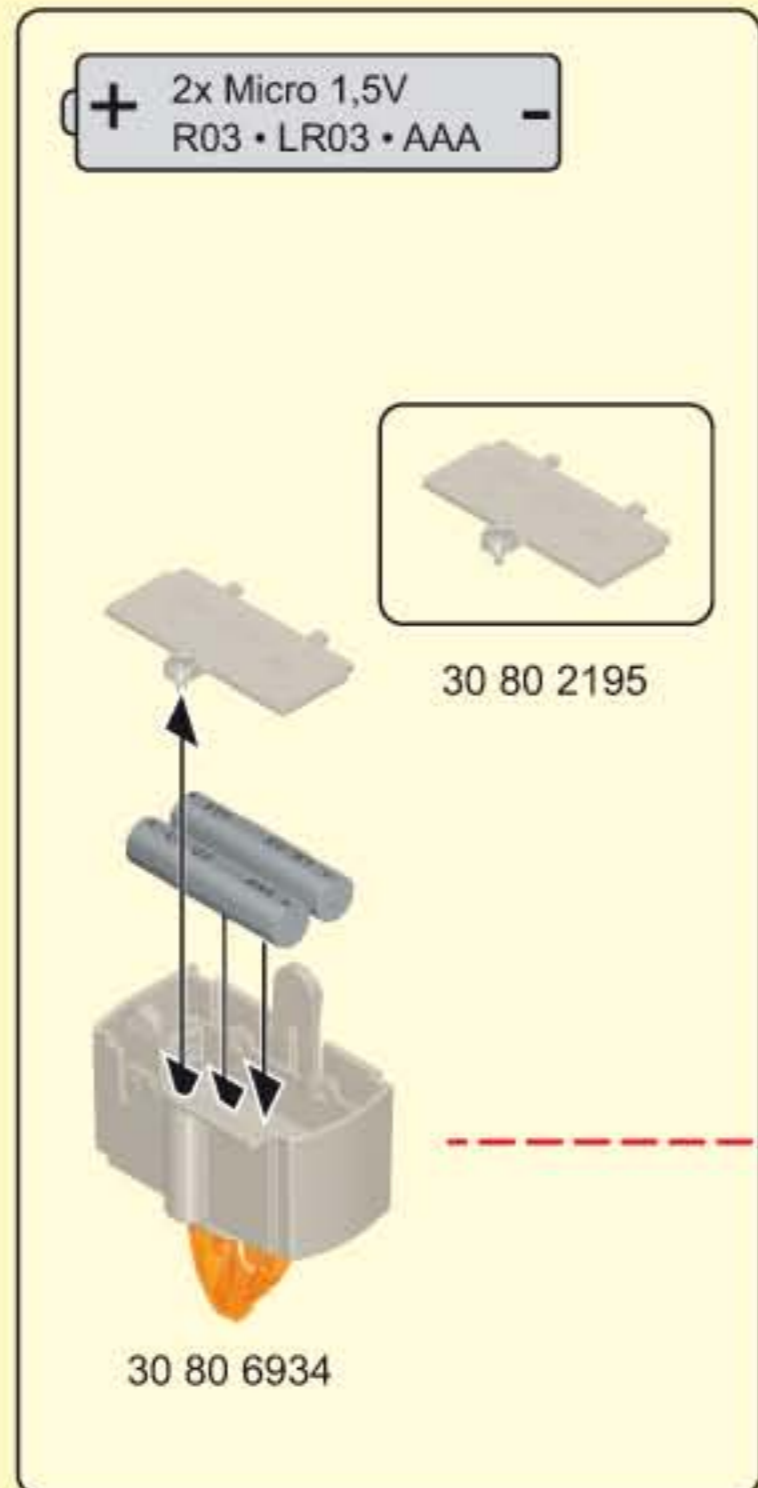

An / Aus  
On / Off  
Marche / Arrêt

2x



3x



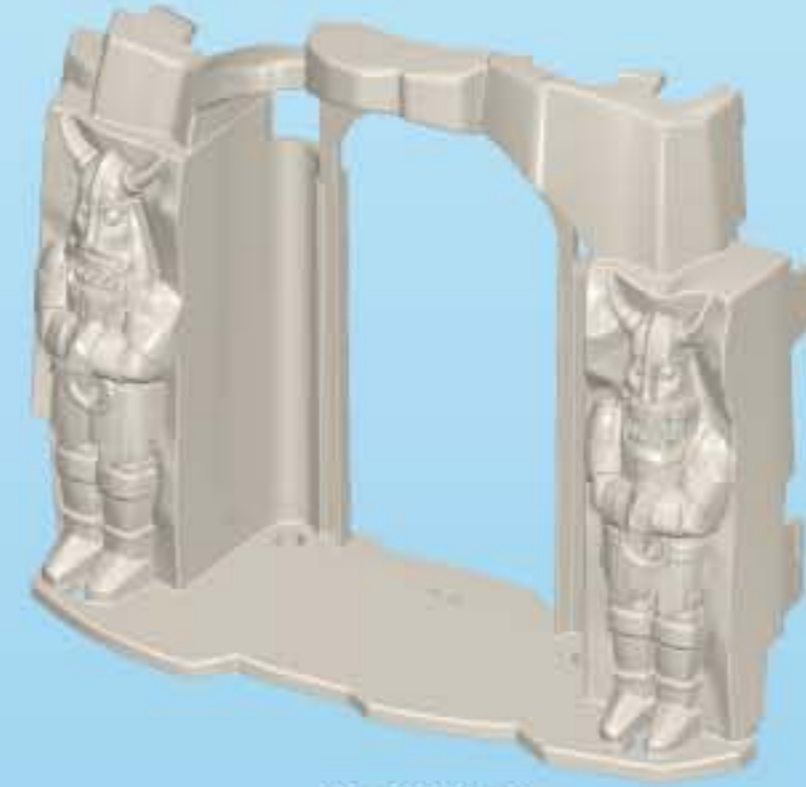
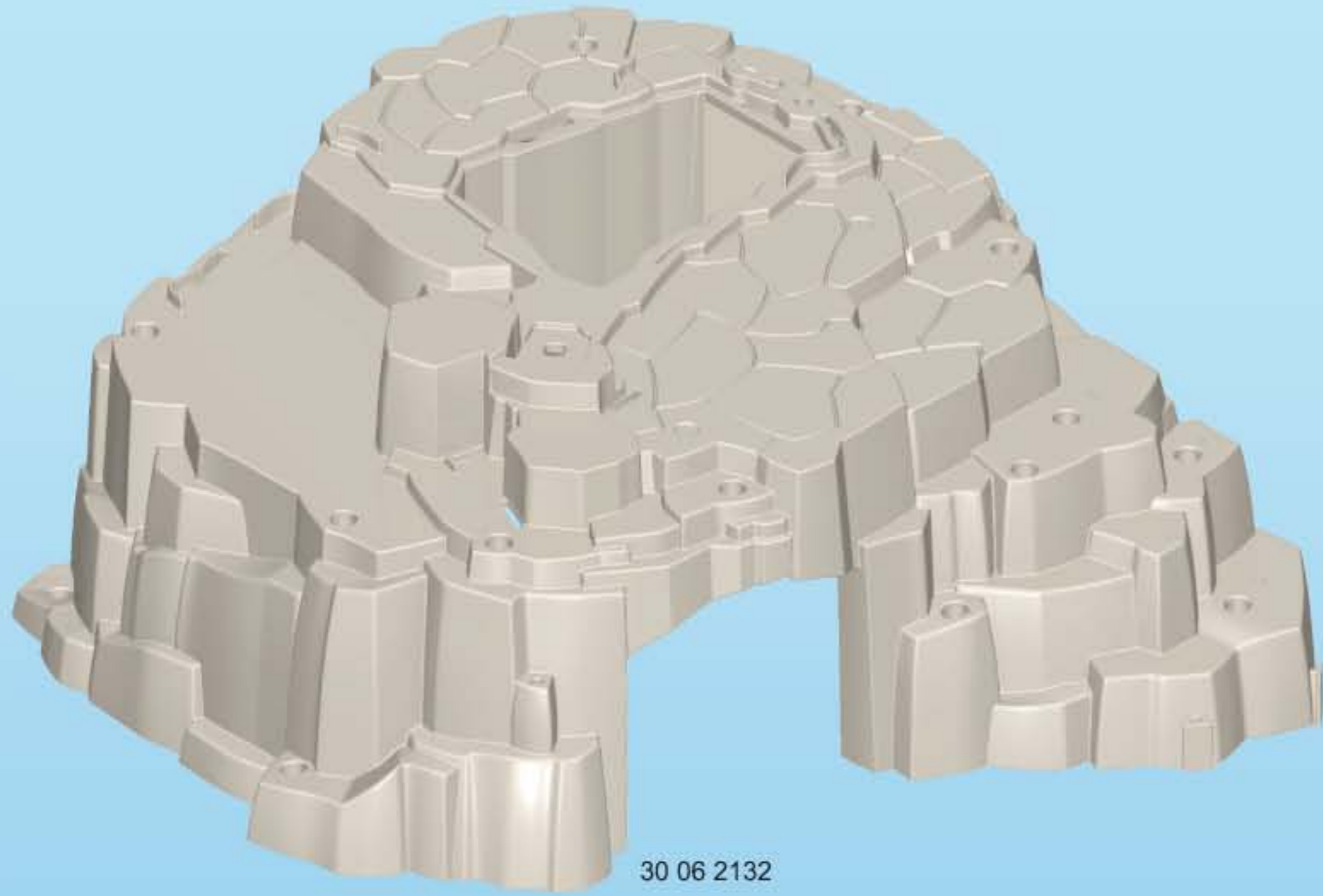





30 06 1992



30 06 1982



30 06 2002



30 06 1972



30 06 2012



30 06 1852



30 06 1912



30 06 1892



30 06 1922



30 06 1902



30 06 1862



30 06 1882

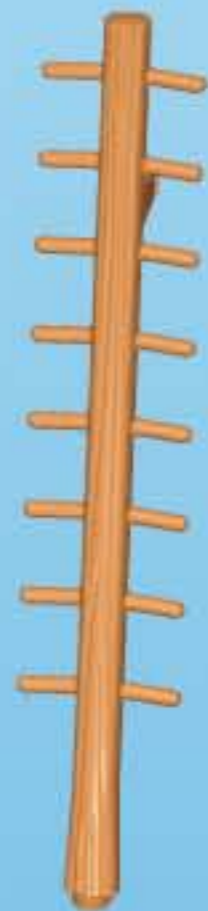

30 06 2182



2x 30 03 1750



30 09 8680



30 06 2042



30 06 2052



30 06 2022



30 06 2032



30 06 2062

A



30 06 2072

B



C

30 06 2082



D

30 06 2092



E

30 06 2102



F

30 06 2112



G

30 06 2122



30 80 6954



30 80 2185

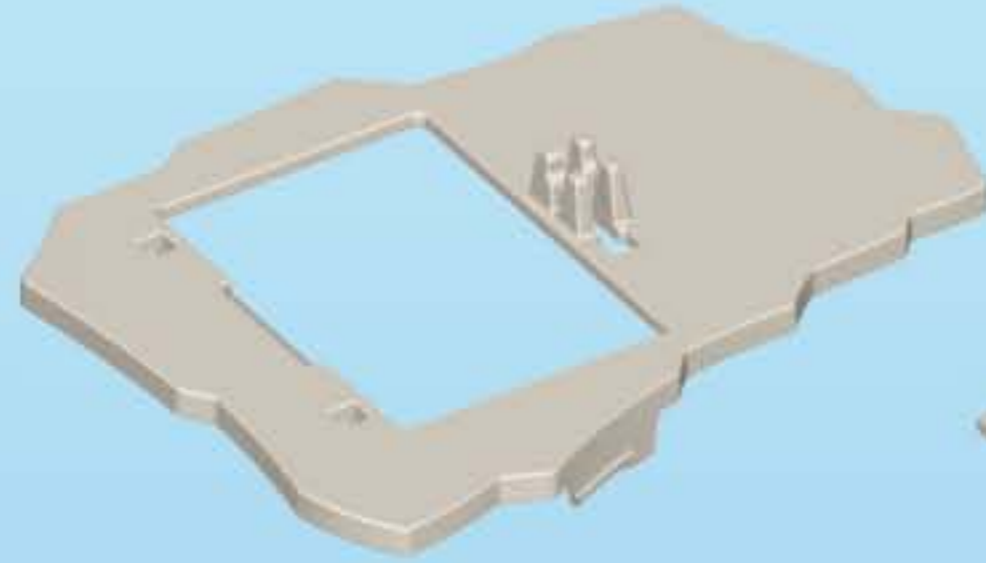

30 06 2162



30 20 7713

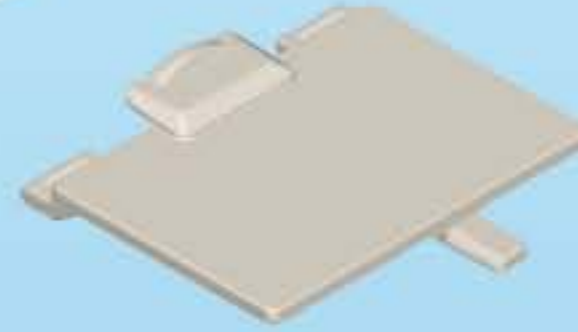

30 06 2172



30 07 1802



2x 30 06 1802



2x 30 06 1692



30 67 1773



30 20 5260



30 06 1642



30 06 1622



30 02 8080

30 02 6760



30 02 6750



30 06 1682

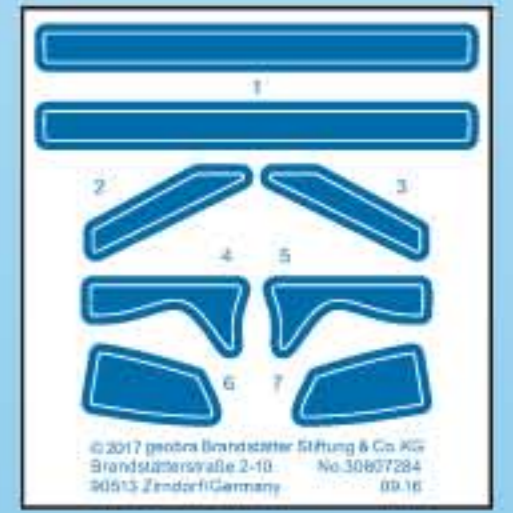

30 80 7284



30 24 8240



30 06 1652



30 27 6840



30 63 2505



3x 30 02 2142



2x 30 20 5482



3x 30 06 1632



4x 30 26 6130



30 22 8023



30 22 8033

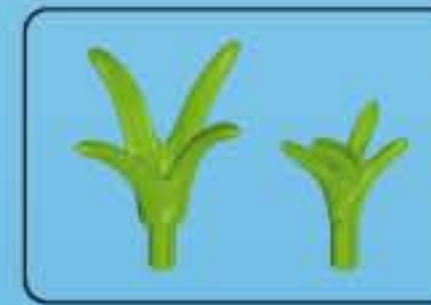

30 60 6610

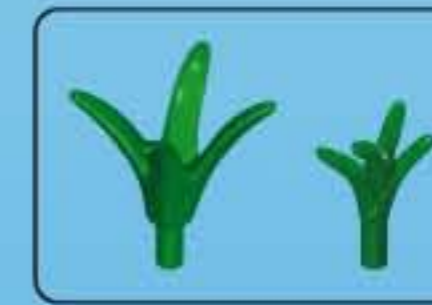

3x 30 61 4630



30 60 7202





30 06 1062



3x 30 29 3940



30 09 0930



30 03 1590



30 07 6420



30 07 2809



30 80 2950



2x 30 25 1190



3x 30 22 6242



30 67 1660



30 67 3770



30 06 1672



3x 30 06 1662



2x 30 03 6600



30 04 0240



30 25 6230



30 51 3380

**(D) (A) (CH) (L) (B) Denken Sie an den Schutz der Umwelt !**

- Ihr Gerät enthält wertvolle Rohstoffe, die wieder verwertet werden können.
- Geben Sie Ihr Gerät deshalb bitte bei einer Sammelstelle Ihrer Stadt oder Gemeinde ab.

**(GB) (M) (IRL) Environment protection first !**

- Your appliance contains valuable materials which can be recovered or recycled.
- Leave it at a local civic waste collection point.

**(F) (L) (CH) Participons à la protection de l'environnement !**

- Votre appareil contient de nombreux matériaux valorisables ou recyclables.
- Confiez celui-ci dans un point de collecte pour que son traitement soit effectué.

**(E) Participa en la conservación del medio ambiente !!**

- Su electrodoméstico contiene materiales recuperables y/o reciclables.
- Entréguelo al final de su vida útil, en un Centro de Recogida Específico o en uno de nuestros Servicios Oficiales Post Venta donde será tratado de forma adecuada.

**(NL) (B) Samen het milieu beschermen !**

- Uw product bevat meerdere recycleerbare materialen
- Breng deze naar een afval-inzamelpunt.

**(B) Participons à la protection de l'environnement !**

- Votre appareil contient de nombreux matériaux valorisables ou recyclables.
- Confiez celui-ci dans un point de collecte ou à défaut dans un centre service agréé pour que son traitement soit effectué.

**(I) (CH) Partecipiamo alla protezione dell'ambiente !**

- Il vostro apparecchio è composto da diversi materiali che possono essere riciclati.
- Lasciatelo in un punto di raccolta o presso un Centro Assistenza Autorizzato.

**(P) Protecção do ambiente em primeiro lugar !**

- O seu produto contém materiais que podem ser recuperados ou reciclados.
- Entregue-o num ponto de recolha para possibilitar o seu tratamento.

**(DK) Vi skal alle være med til at beskytte miljøet!**

- Apparatet indeholder mange materialer, der kan genvindes eller genbruges.
- Bring det til et specialiseret indsamlingssted for genbrug eller et autoriseret serviceværksted, når det ikke skal bruges mere.

**(S) (FIN) Var rädd om miljön!**

- Din apparat innehåller olika material som kan återanvändas eller återvinnas.
- Lämna den på en återvinningsstation eller på en auktoriserad serviceverkstad för omhändertagande och behandling.

**(FIN) Huolehtikaamme ympäristöstä!**

- Laitteesi on varustettu monilla arvokkailla ja kierrätettävillä materiaaleilla.
- Toimita laitteesi keräyspisteeseen tai sellaisen puuttuessa vaikka valtuutettuun huoltokekkukseen, jotta laitteen osat varmasti kierrätetään.

**(H) Első a környezetvédelem!**

- Az Ön terméke értékes újrahasznosítható anyagokat tartalmaz.
- Kérjük készülékét ne dobja ki, hanem adja le az erre a célra kijelölt gyűjtőhelyen.

**(CZ) Podílejme se na ochraně životního prostředí!**

- Váš přístroj obsahuje čtené zhodnotitelné nebo recyklovatelné materiály.
- Světe jej sběrnému místu nebo, neexistuje-li, smluvnímu servisnímu středisku, kde s ním bude naloženo odpovídajícím způsobem.

**(SLO) Sodelujmo pri varovanju okolja!**

- Vaš aparat vsebuje številne dele, ki imajo svojo vrednost ali jih je še mogoče uporabiti.
- Oddajte ga na mestu za zbiranje odpadkov ali pa na pooblaščenem servisu, da bo šel v predelavo.

**(SK) Podieľajme sa na ochrane životného prostredia!**

- Váš prístroj obsahuje čtené zhodnotiteľné alebo recyklovateľné materiály.
- Zverte ho sběrnému miestu alebo, ak neexistuje, zmluvnému servisnému stredisku, kde s ním bude naložené zodpovedajúcim spôsobom.

**(PL) Bierzmy czynny udział w ochronie środowiska!**

- Twoje urządzenie jest zbudowane z materiałów, które mogą być poddane ponownemu przetworzeniu lub recyklingowi.
- W tym celu należy je dostarczyć do wyznaczonego punktu zbiórki.

**(GR) (CY) Ας συμβάλουμε κι εμείς στην προστασία του περιβάλλοντος!**

- Η συσκευή σας περιέχει πολλά αξιοποιήσιμα ή ανακυκλώσιμα υλικά.
- Παραδώστε την παλιά συσκευή σας σε κέντρο διαλογής ή σε ένα εξουσιοδοτημένο κατάστημα σέρβις.

**(RO) Țineți cont de protecția mediului !**

- Aparatul dvs. conține materii prime valoroase care pot fi revalorificate.
- Din acest motiv vă rugăm să predați aparatul dvs. la un centru de colectare din orașul sau comuna dvs.

**(BG) Мислете за околната среда !**

- Вашият уред съдържа ценни суровини, които могат да бъдат рециклирани.
- Затова върнете своя електроуред на специално място за събиране на такива отпадъци във Вашия град или община.

**(USA)**

This device complies with Part 15 of the FCC Rules. Operation is subject to the following two conditions:

- (1) This device may not cause harmful interference, and
- (2) this device must accept any interference received, including interference that may cause undesired operation.

**(CDN) CAN ICES-3 (B)/NMB-3(B)**

Cet équipement est conforme à la Section 15 des règlements de la FCC. Son fonctionnement est soumis aux deux conditions suivantes:

- (1) Cet équipement ne peut causer d'interférence nuisible, et
- (2) cet équipement doit pouvoir fonctionner même s'il capte de l'interférence, incluant celle pouvant provoquer un fonctionnement indésirable.

Serviceadressen finden Sie in allen Playmobil-Prospekten

Addresses of Customer Service Departments are shown in all Playmobil catalogues

L'adresse du service consommateurs est indiquée dans tous les catalogues Playmobil

Troverete gli indirizzi dei centri di assistenza in tutti i cataloghi Playmobil

In alle PLAYMOBIL cataloghi vindt u het adres van onze klantendienst.

Las Direcciones de los Departamentos de Servicio al Consumidor se encuentran en todos los catálogos Playmobil

Η διεύθυνση του Γραφείου Εξυπηρέτησης Καταναλωτών PLAYMOBIL βρίσκεται σε όλους τους καταλόγους PLAYMOBIL.

pronounce: plāy-mō-bēēl

