

 **WARNING:**
CHOKING HAZARD
Small parts. Not for children under 3 years.
"Ne concerne que les USA"

Wichtige Unterlagen, bitte sorgfältig aufbewahren!
Important documents keep carefully!
Documents importants conservez avec soin!
Belangrijke documenten, bewaar deze zorgvuldig!

1

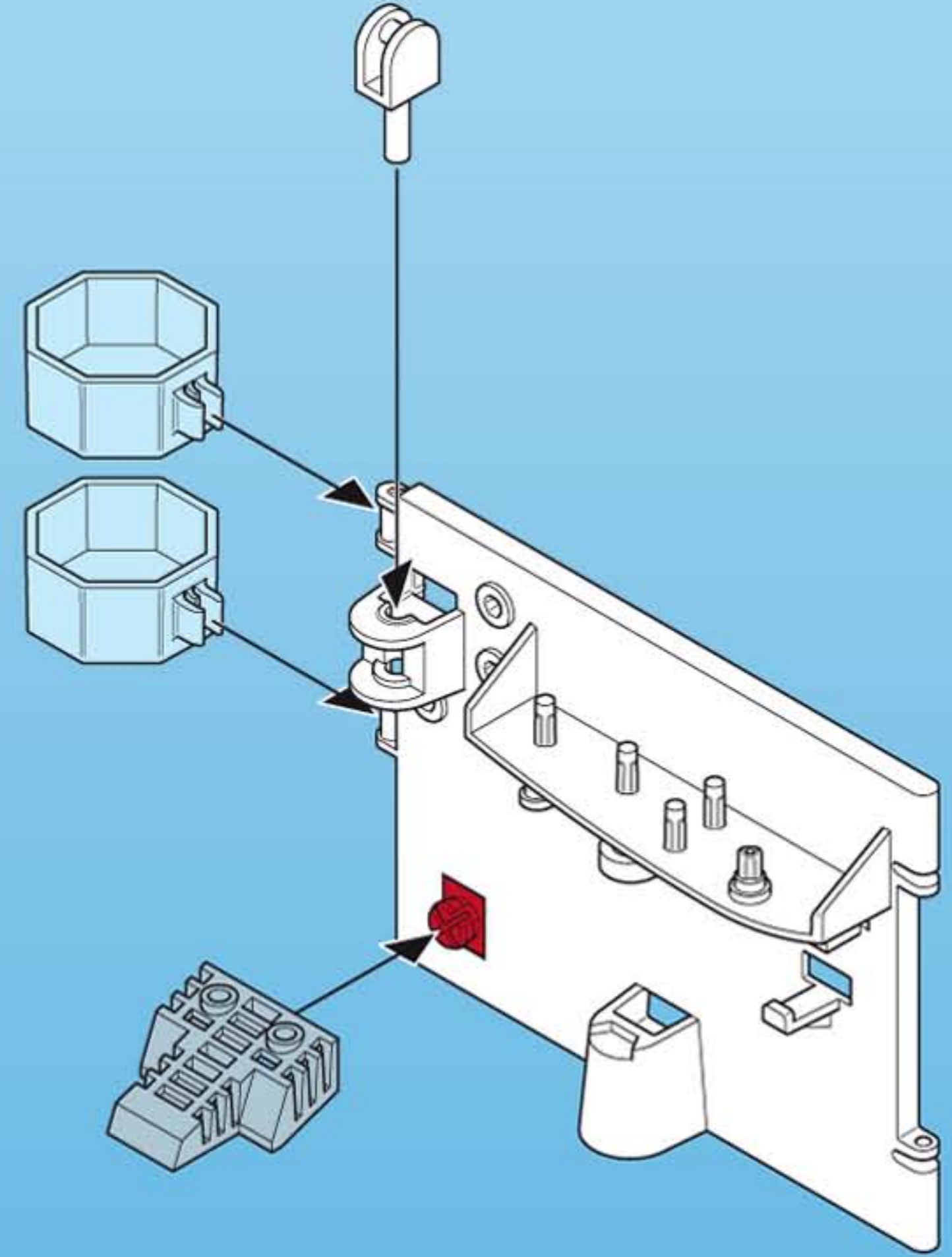

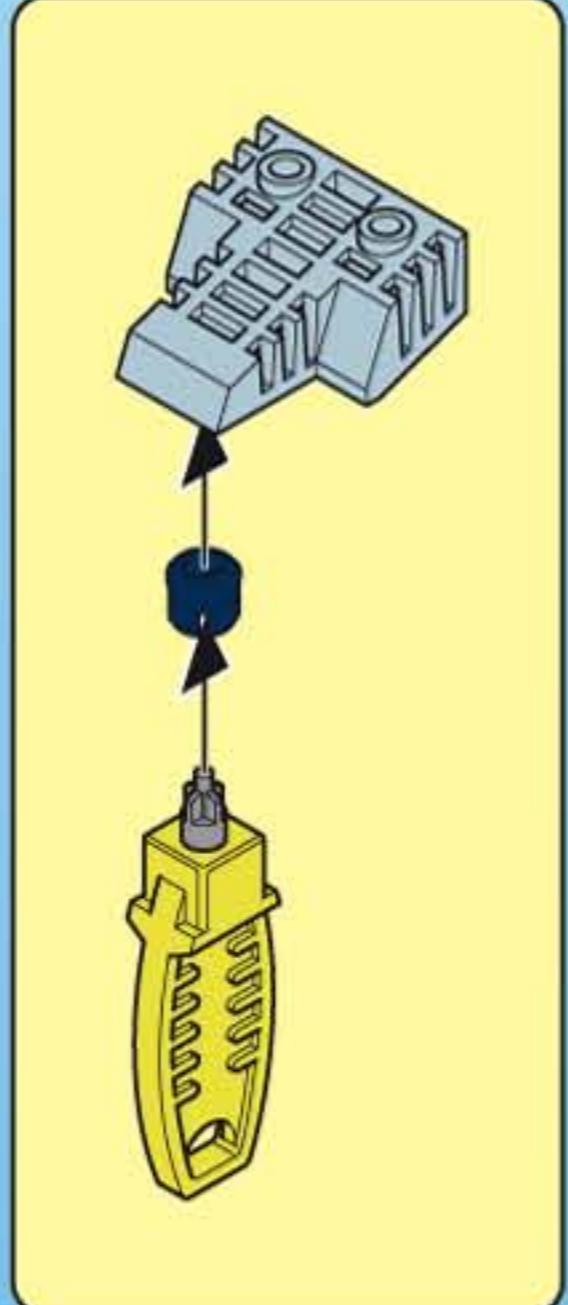
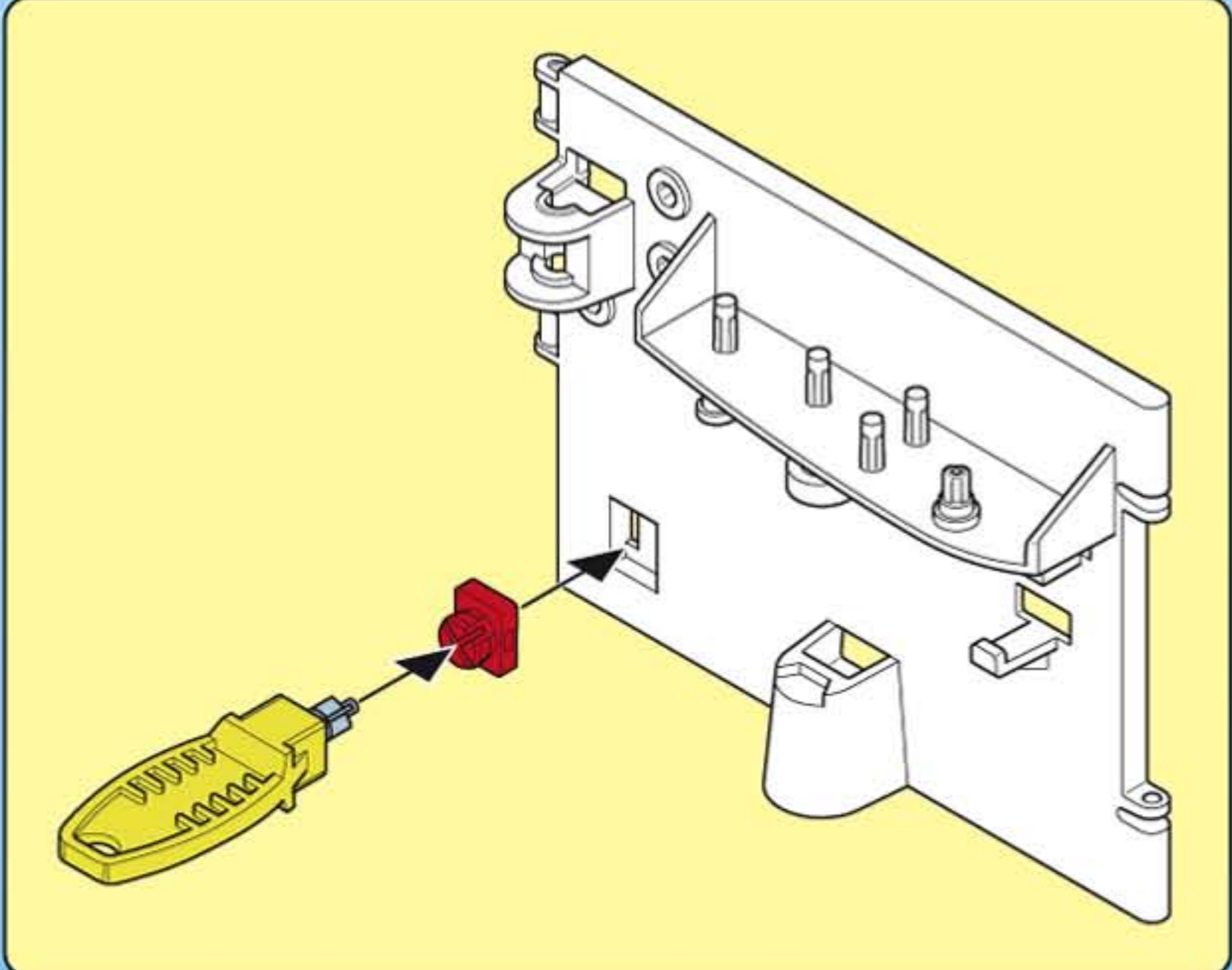
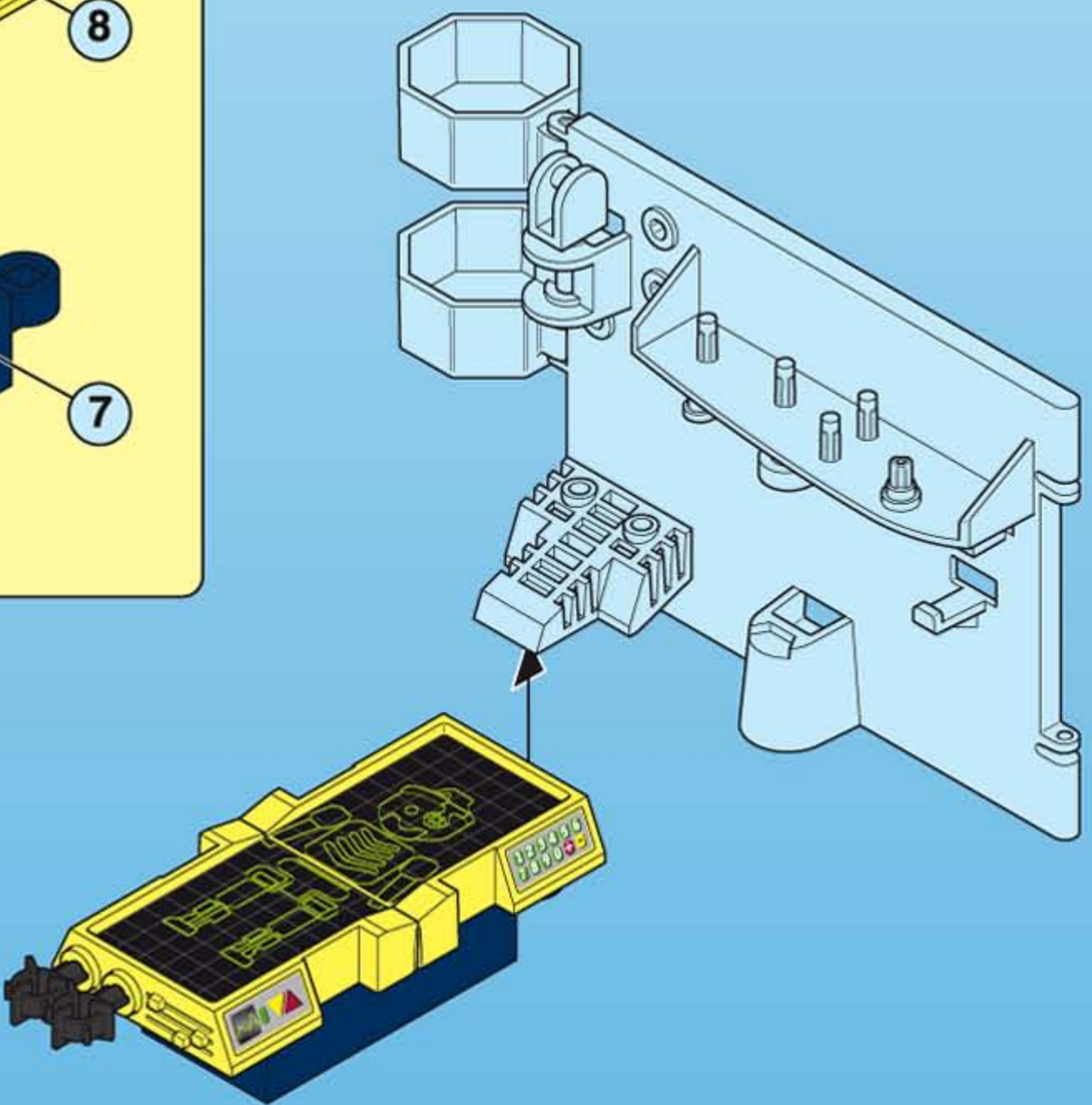
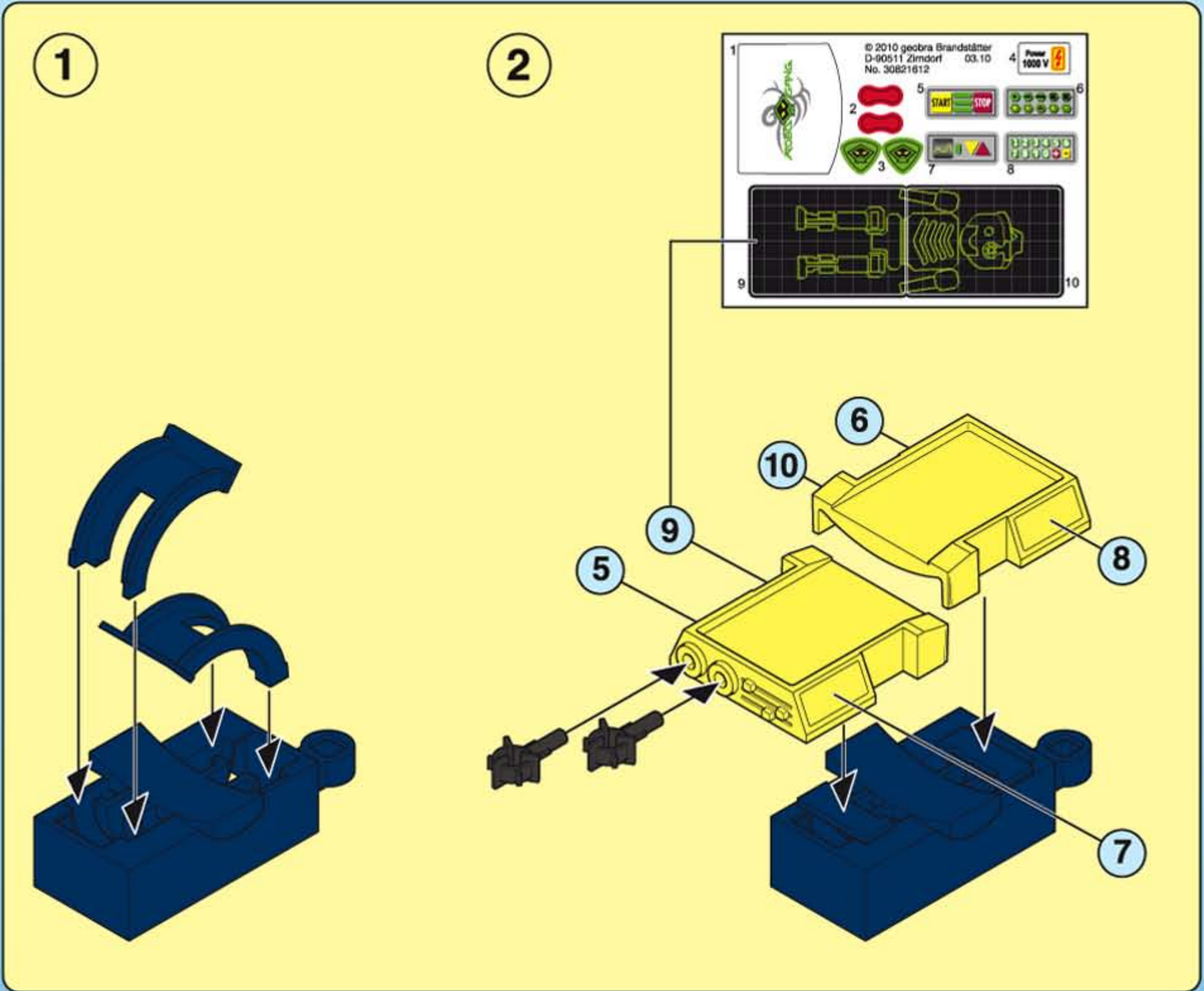

3

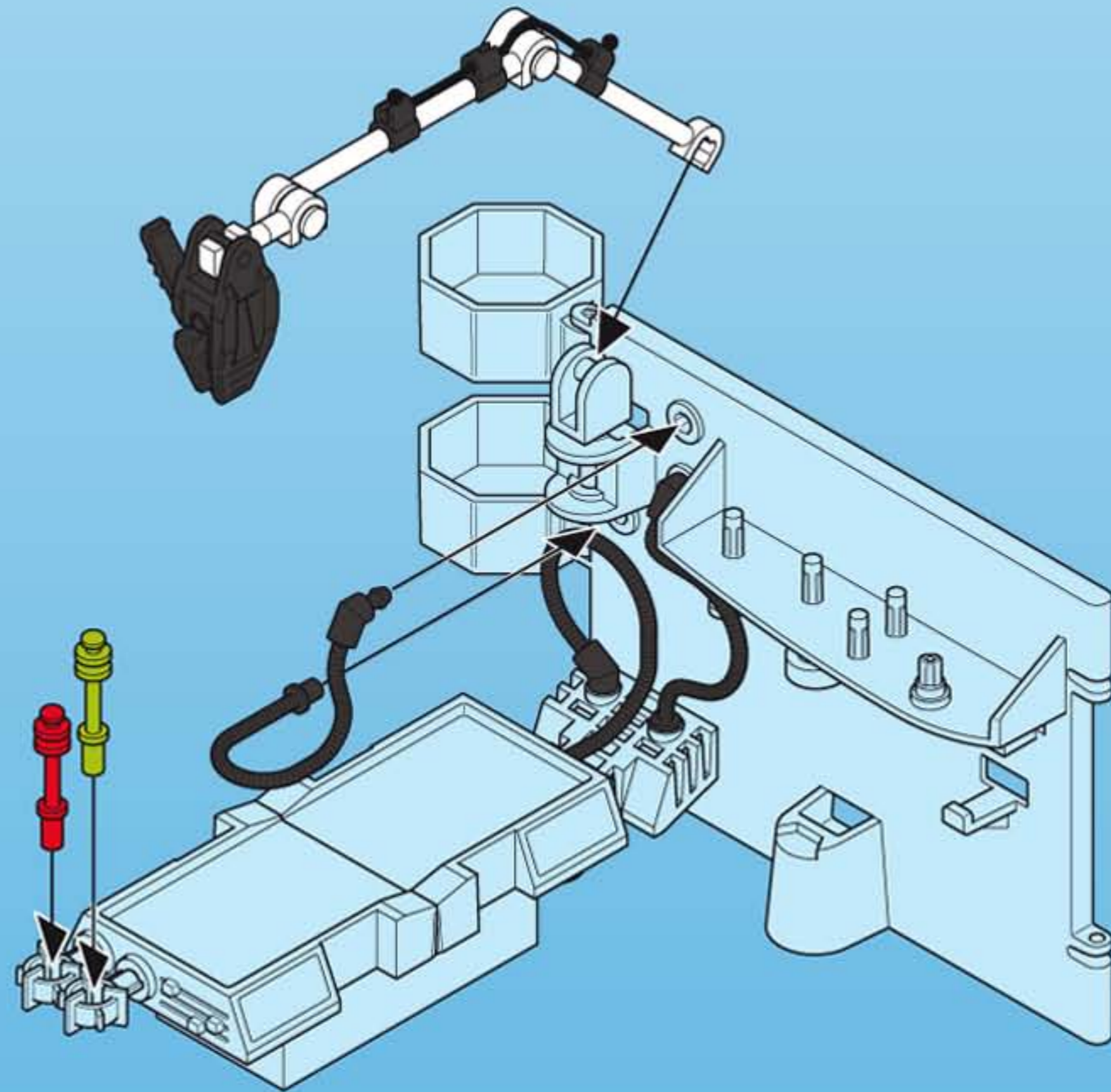
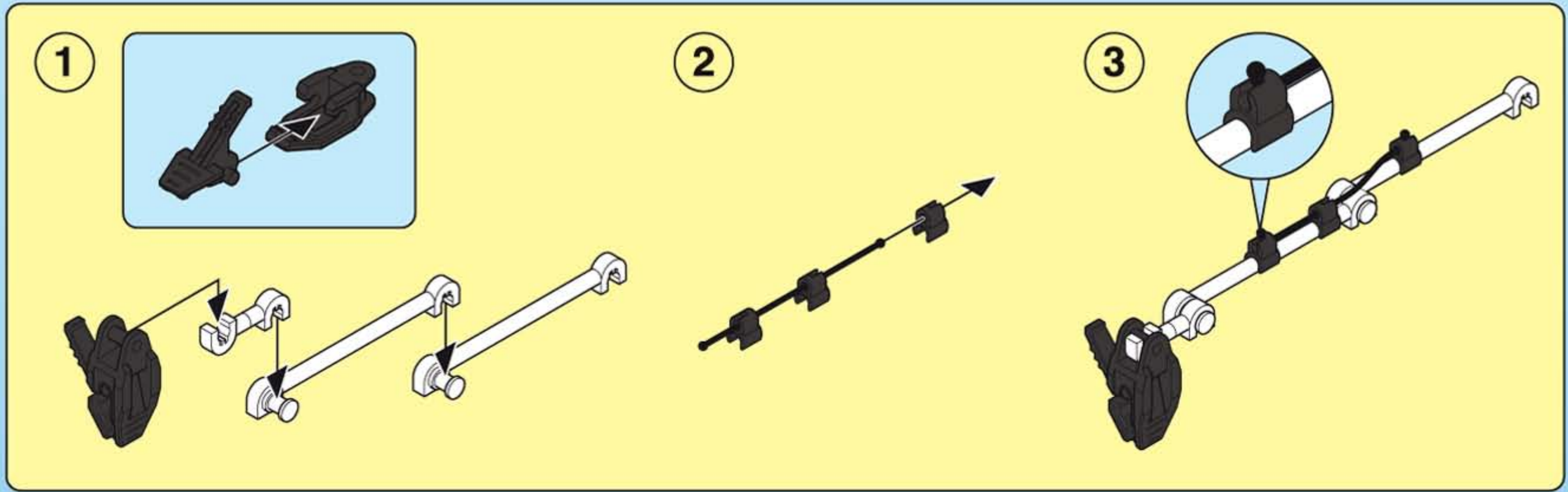

1

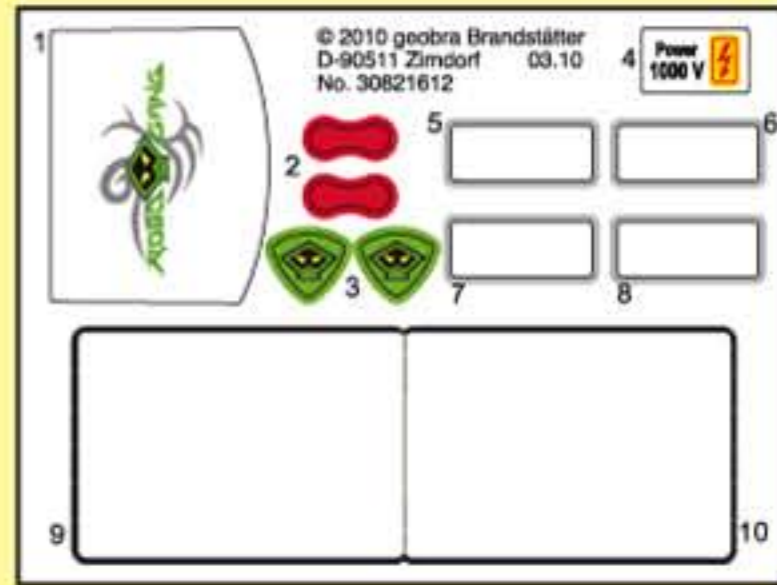

2

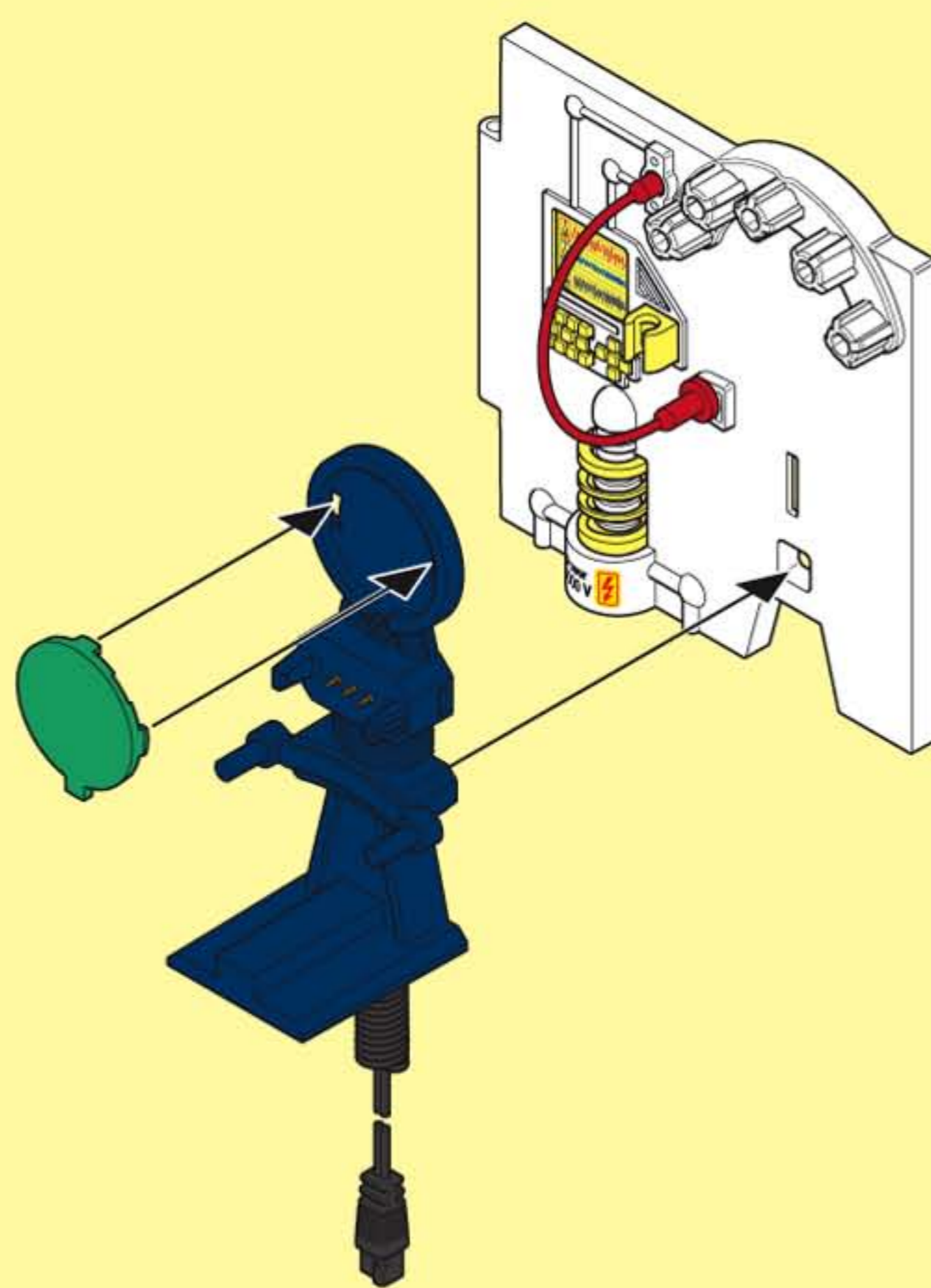

3

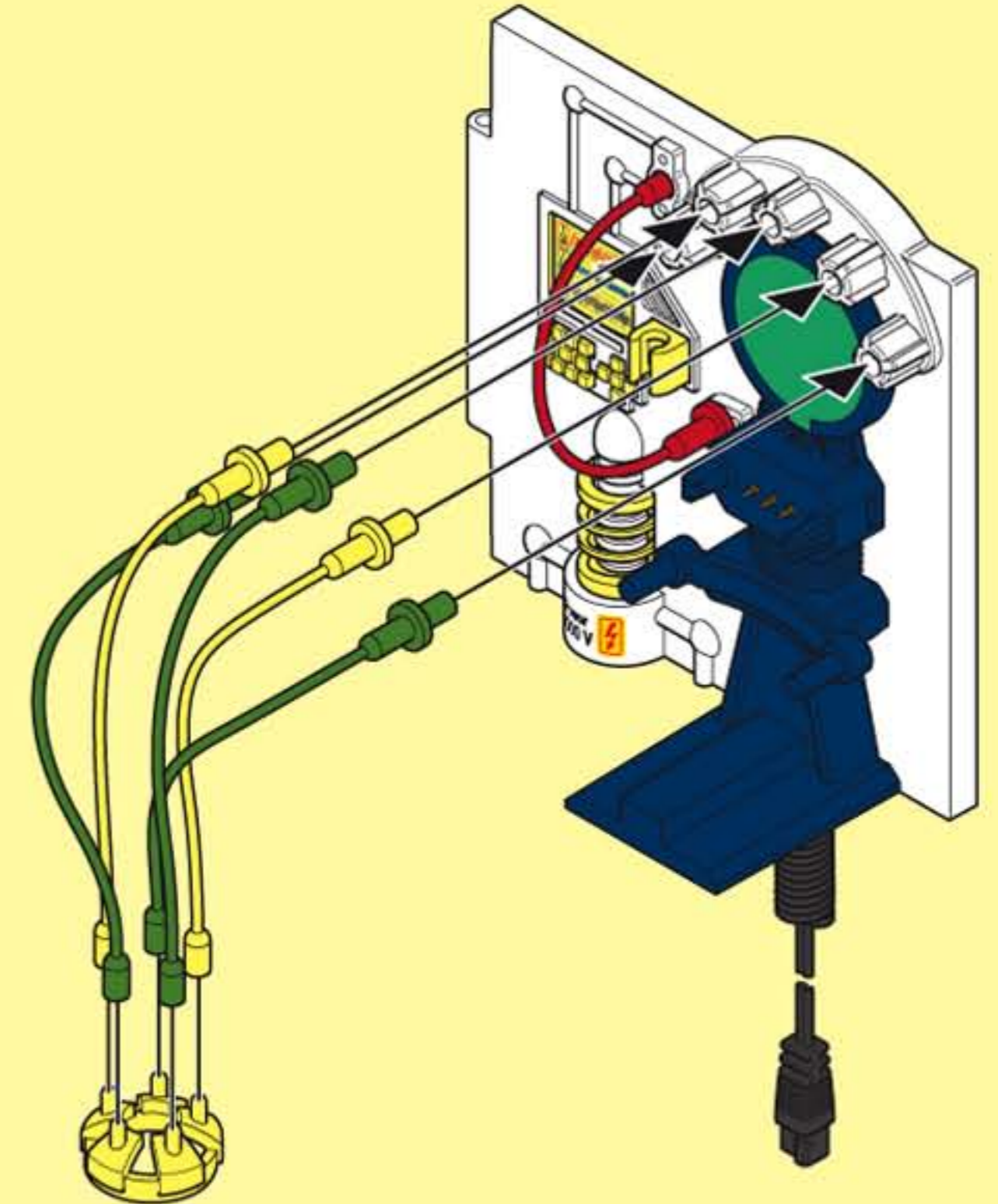

4

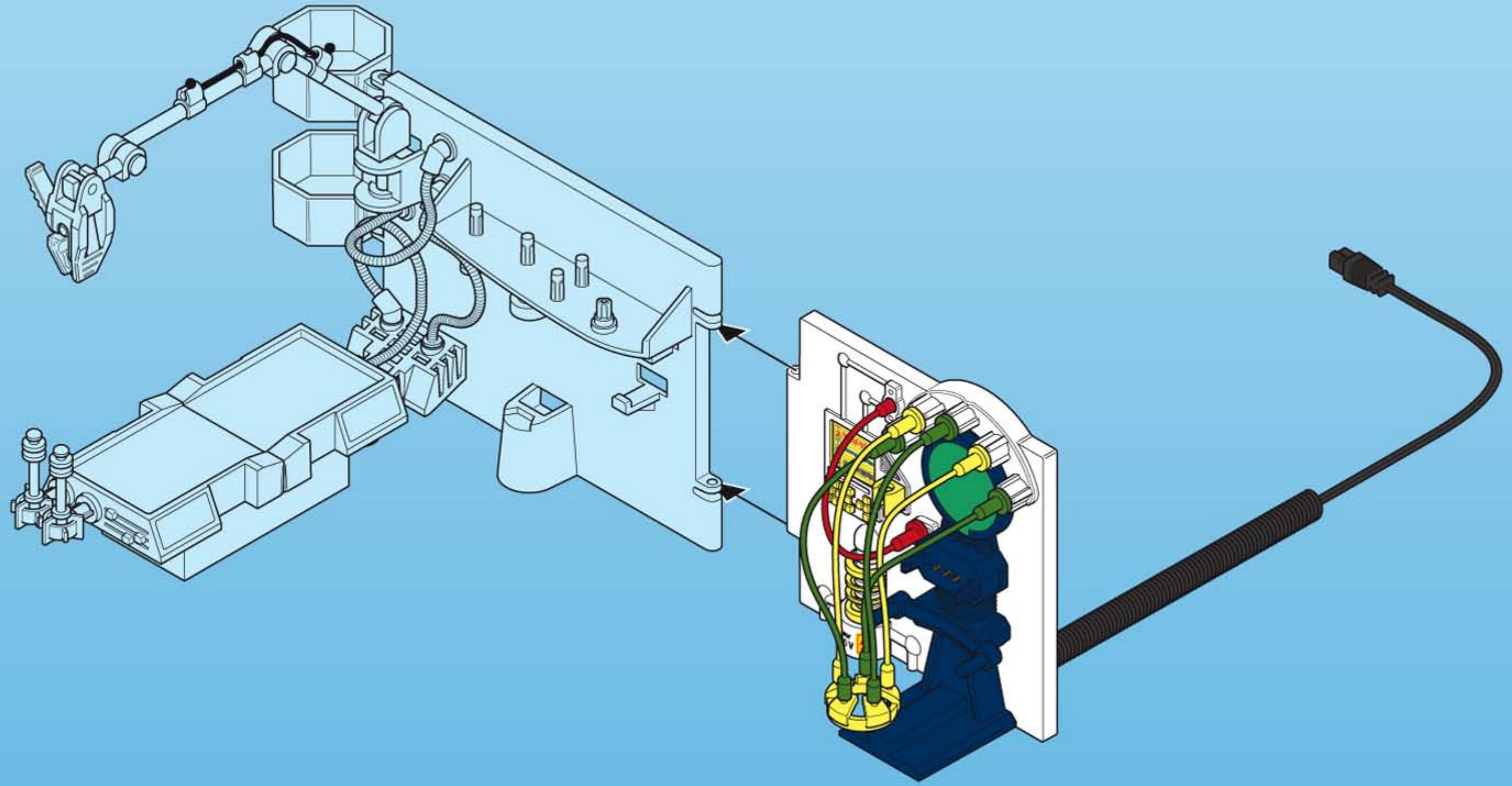

5

5

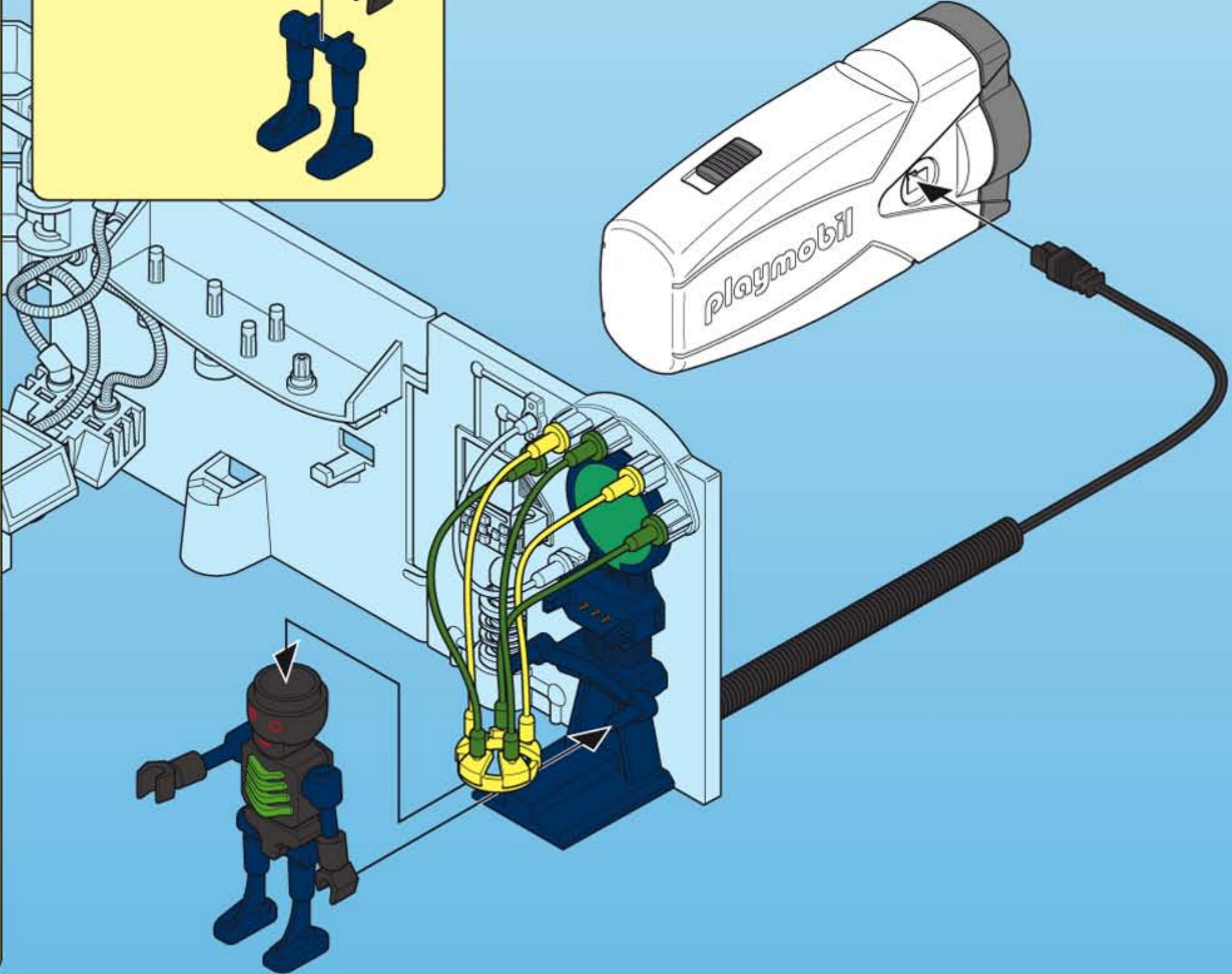
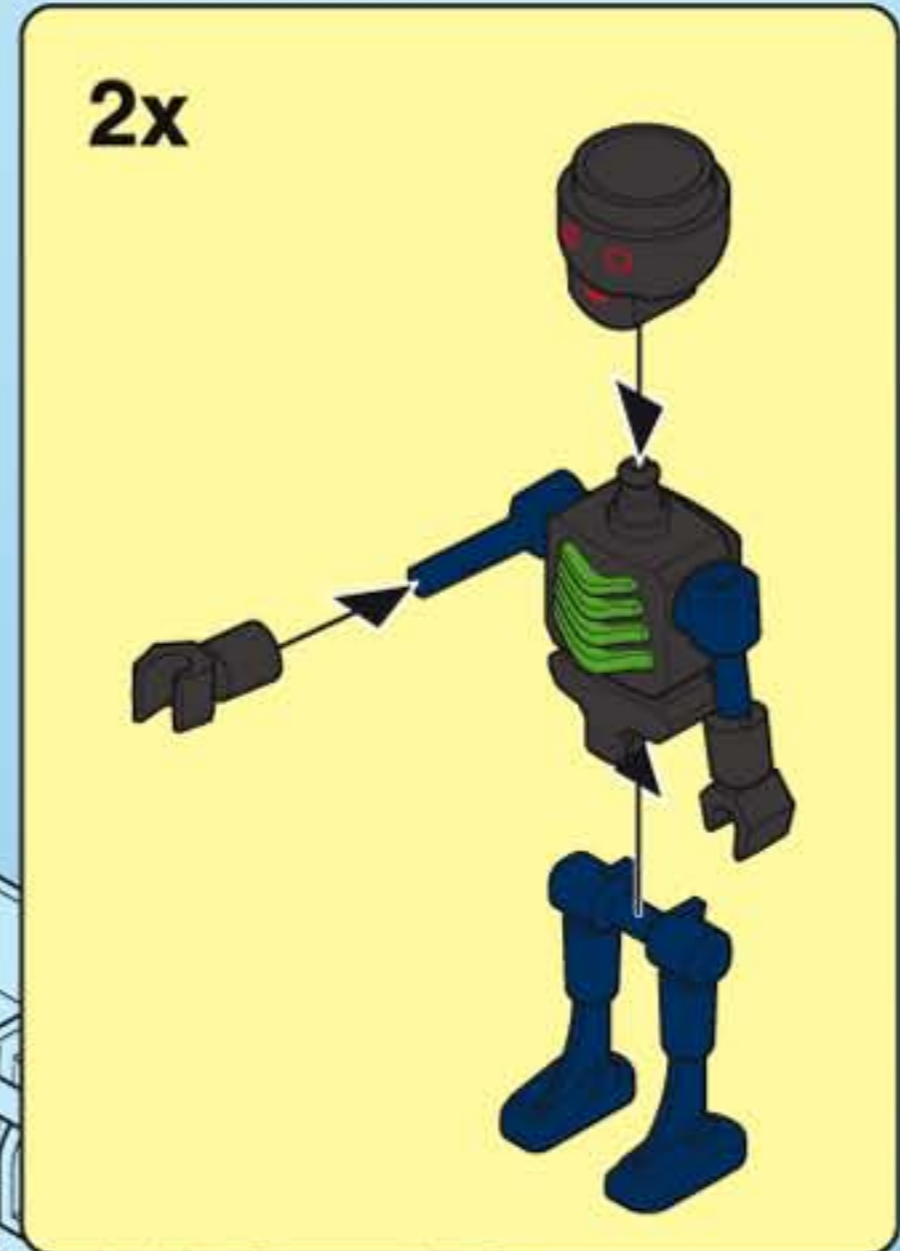
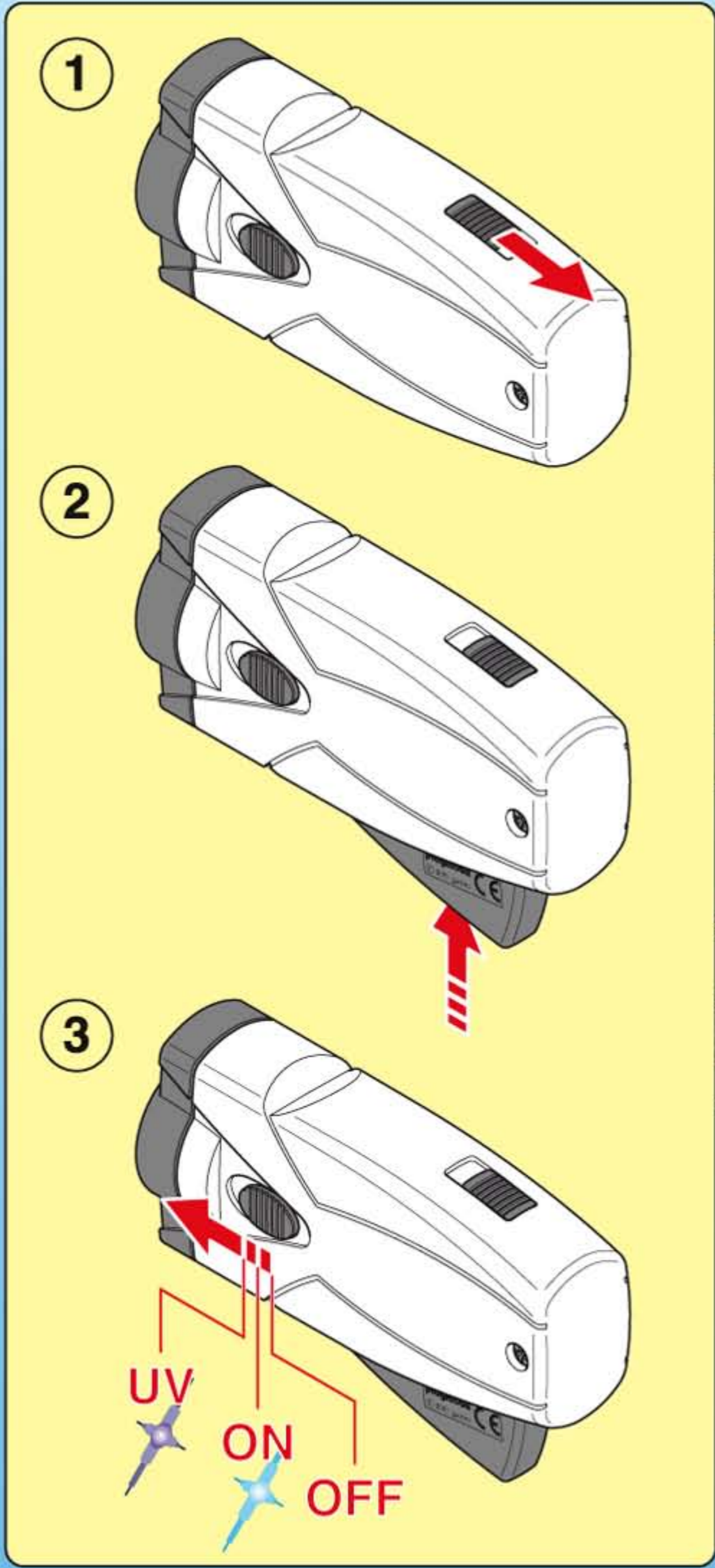

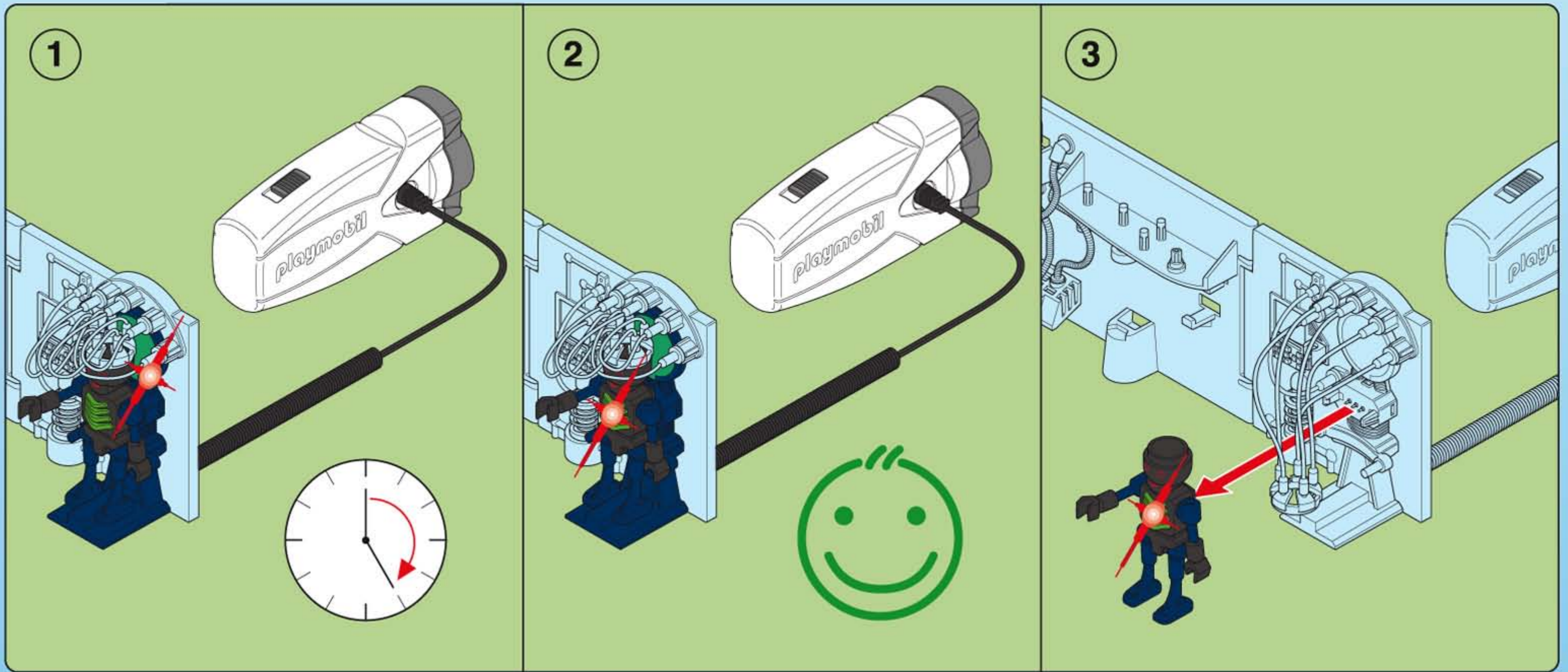

2x

30 21 5812

30 82 2792

30 82 2802

30 21 5822

30 21 5952

30 21 5862

1

30 21 5872

30 21 5882

© 2010 geobra Brandstätter
D-90511 Zimndorf 03.10
No. 30821612

2x

30 21 5782

2

© 2010 geobra Brandstätter
D-90511 Zimndorf 03.10
No. 30821612

30 51 8110

3

3

© 2010 geobra Brandstätter
D-90511 Zimndorf 03.10
No. 30821612

30 51 8110

30 51 8120

30 28 8680

30 28 8690

30 20 2082

30 20 1262



30 00 7952

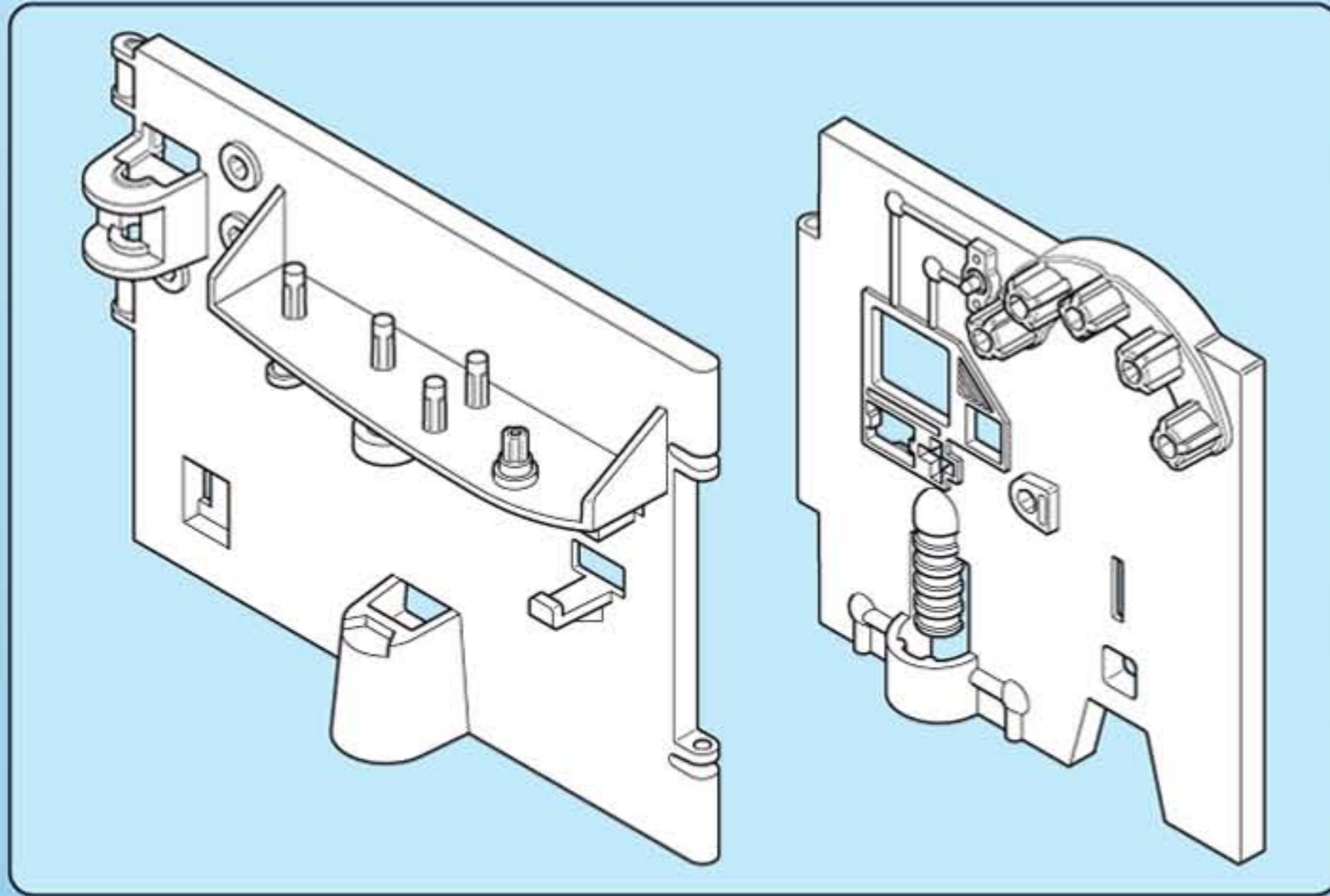

30 51 8130

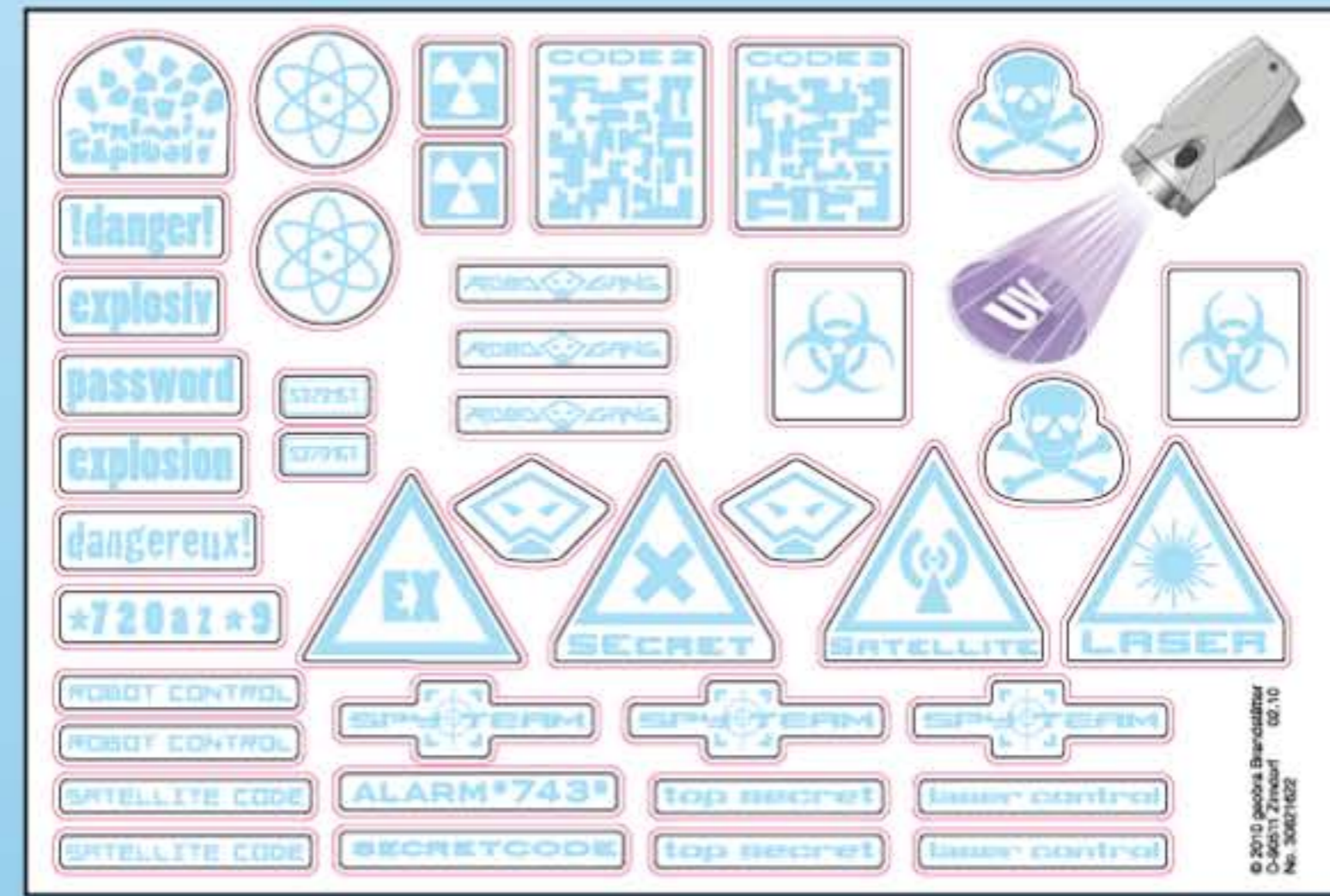

30 82 1622



30 66 1142

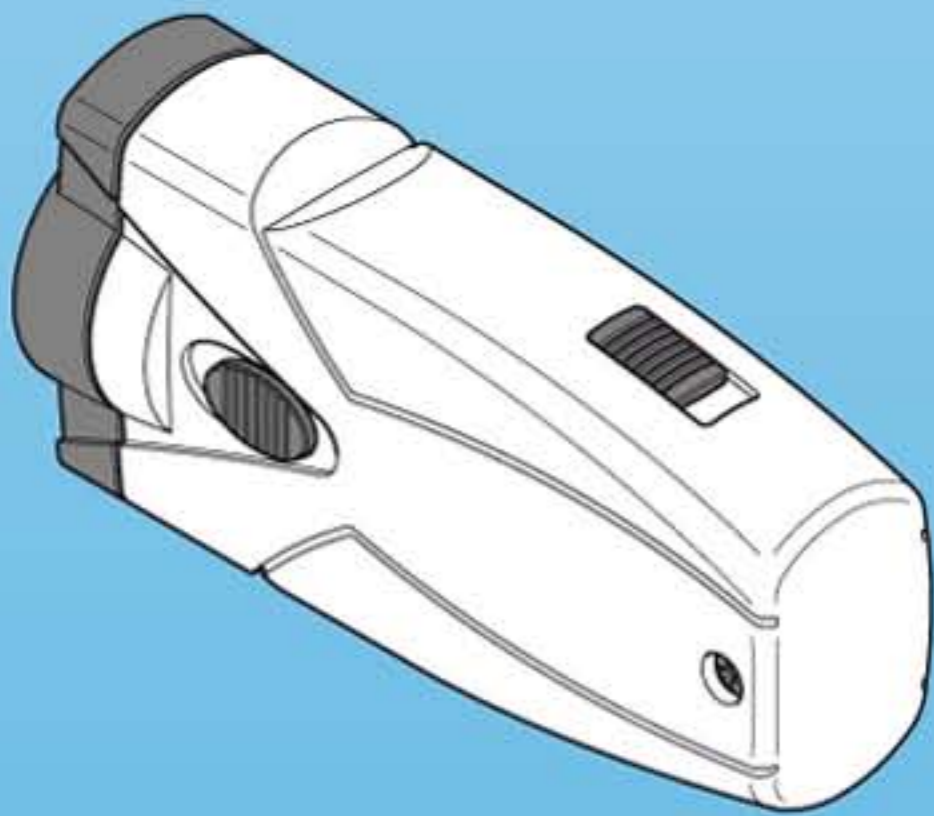

30 82 2962

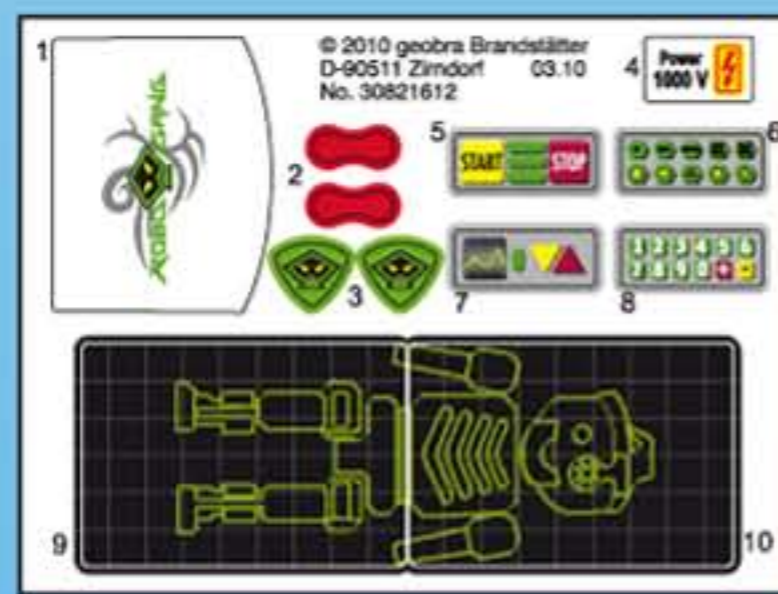

30 82 1612

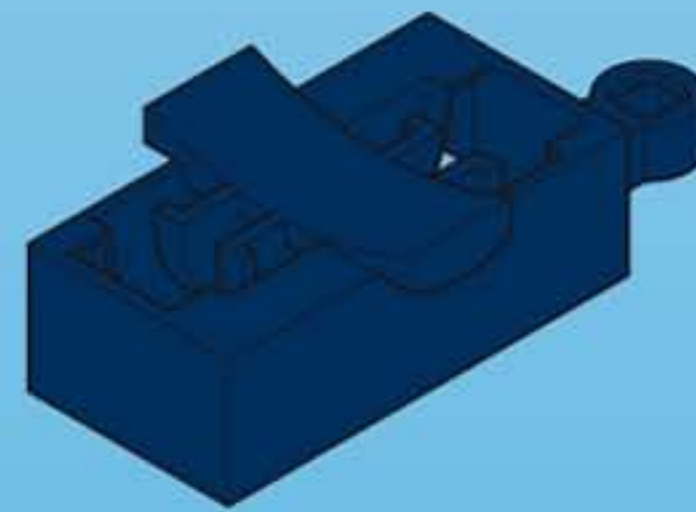

30 21 5832

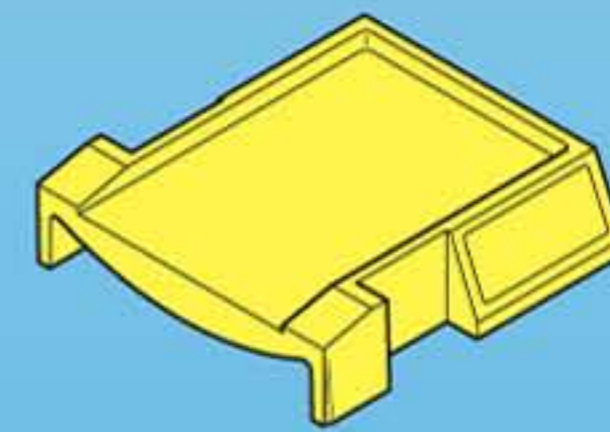

2x 30 21 5802

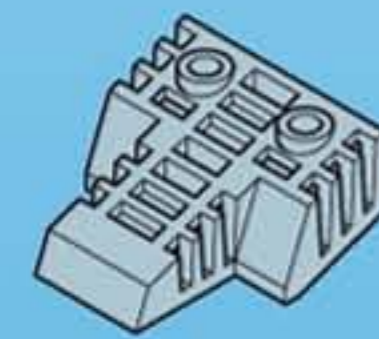

30 21 5852



30 65 8822



2x 30 21 5842



2x 30 66 1122

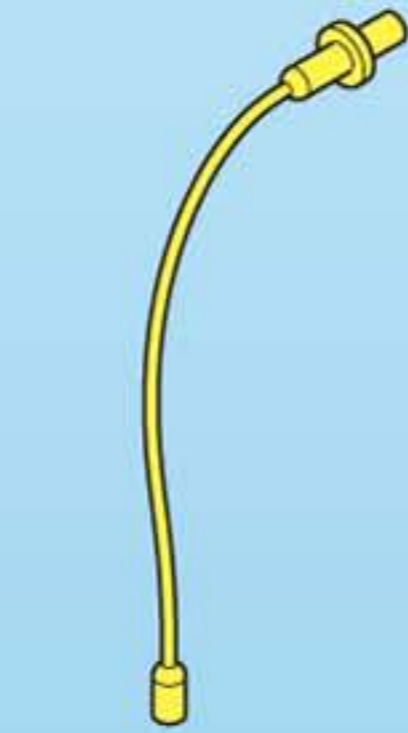

2x 30 82 3012

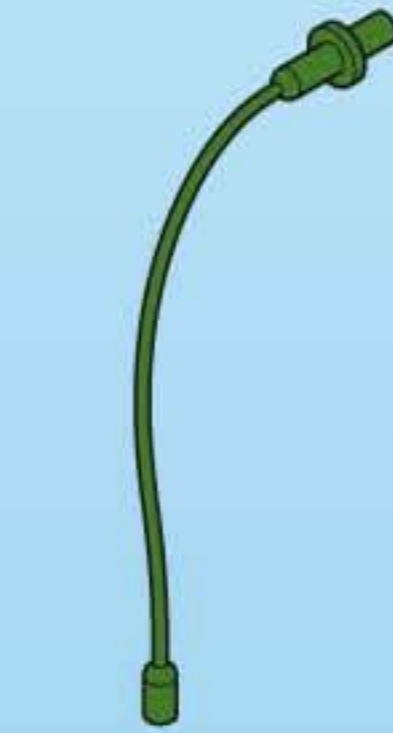

3x 30 82 3002

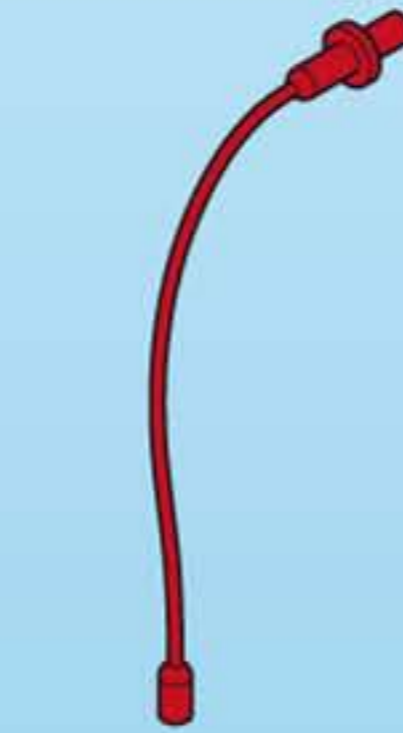

30 82 2992



2x 30 21 5752

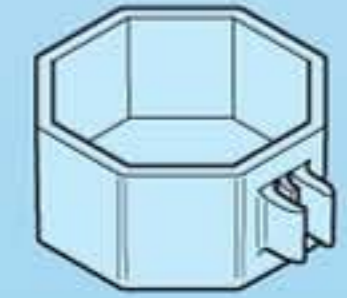

2x 30 21 5792

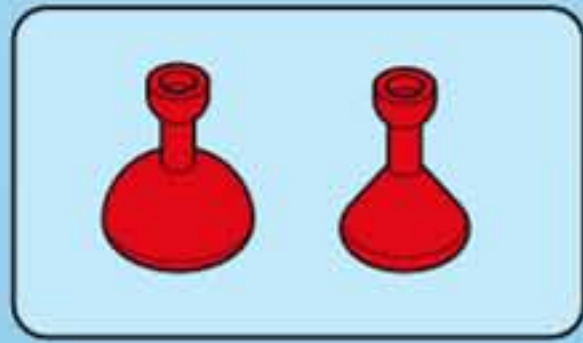

30 60 5820



30 21 5912



30 62 1453



30 21 5772



2x 30 66 1132



30 21 9262



3x 30 23 5630

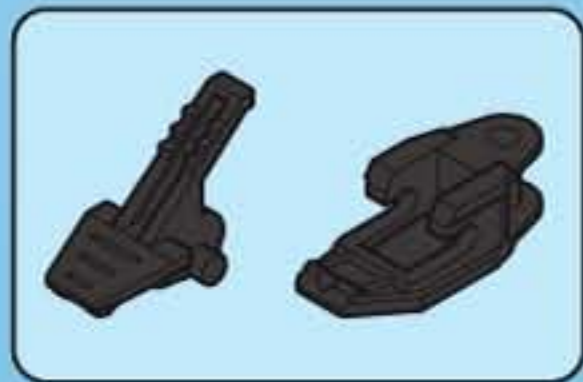

30 60 0792

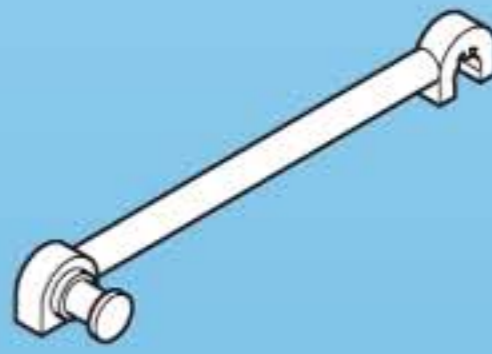

2x 30 46 4560



30 51 8120



30 21 3770



30 21 5200



30 28 8760



30 46 4570



4x 30 21 5762



2x 30 03 4630



3x 30 29 3710



2x 30 21 2790



30 09 6900



30 21 5902

Serviceadressen finden Sie in allen Playmobil-Prospekten

Addresses of Customer Service Departments are shown in all Playmobil catalogues

L'adresse du service consommateurs est indiquée dans tous les catalogues Playmobil

Troverete gli indirizzi dei centri di assistenza in tutti i cataloghi Playmobil

In alle PLAYMOBIL catalogi vindt u het adres van onze klantendienst.

Las Direcciones de los Departamentos de Servicio al Consumidor se encuentran en todos los catálogos Playmobil

Η διεύθυνση του Γραφείου Εξυπηρέτησης Πελατών είναι καταχωρημένη σε όλους τους καταλόγους Playmobil

pronounce: plāy-mō-bēēl

- D** **A** **CH** **L** **B** Batteriebetriebenes Spielzeug mit nicht austauschbaren Batterien. Anschlußklemmen dürfen nicht kurzgeschlossen werden!
- USA** **GB** **CDN** **M** **IRL** Battery operated toy with non-replaceable batteries. Do not short circuit the power connector!
- F** **CDN** **B** **L** **CH** Jouet à piles avec piles non remplaçables. Les connecteurs ne doivent pas être mis en court circuit!
- E** **MEX** El juguete funciona con baterías no intercambiables. No poner en cortocircuito los bornes!
- NL** **B** Werkt op batterijen, batterijen zijn niet vervangbaar. Aansluitklemmen mogen niet kortgesloten worden!
- I** **CH** Giocattolo funzionante a batteria con pile non sostituibili. Non cortocircuitare i connettori!
- P** O brinquedo funciona com baterias não intercambiáveis. Não colocar no curto-circuito os bornes.
- DK** Batteridrevet legetøj med ikke-genopladelige batterier. Polerne må ikke kortsluttes!
- N** Batteridrevet med ikke utskiftbare batterier. Polene må ikke kortslutte!
- S** **FIN** Batteridreven leksak försedd med icke utbytbara batterier. Polerna får ej kortslutas!
- FIN** Toimii paristoilla. Paristot ei-vaihdettavia. Paristojen napoja ei saa oikosulkea.
- H** Elemmel működő játék, melyben az elemek nem cserélhetők! Kérjük ügyeljen, hogy ne okozzon rövidzárlatot!
- CZ** Hračka na baterie s nevyměnitelnou baterií. Připojovací svěrký nesmí dostat elektrický zkrat.
- EST** Mittevahetatavate patareidega patareide abil töötav mänguasi. Vältida kontaktklemmide sattumist lühiühendusse!
- LV** Ar baterijām darbināma rotāļlieta ar nomaināmām baterijām. Kontaktpailes nedrīkst saslēgt īssavienojumā!
- LT** Baterijų varomas žaislas su nekeičiamomis baterijomis. Prijungimo gnybtai negali būti trumpai sujungti!
- SLO** Igrača na nezamenljive baterije. S priključnimi sponkami se ne sme povzročati kratkega stika!
- SK** Hračka na batérie s nevymeniteľnými batériami. Prípojkové svorky sa nesmú spojiť nakrátko!
- PL** Zabawka z niewymienialnymi bateriami. Nie zwierać klem zaciskowych!
- TR** **CY** Pilleri değiştirilemeyen pilli oyuncak. Bağlantı klemensleri kısa devre yapılmamalıdır!
- GR** **CY** Παιχνίδι μπαταρίας με μπαταρίες που δεν αντικαθίστανται. Μην ενώνετε τις υποδοχές των φις για τα φώτα του τρένου μεταξύ τους.
- RO** Jucărie acționată de baterii care nu trebuie înlocuite. Bornele nu au voie să fie scurtcircuitate.
- BG** Задвижвана от батерии играчка с несменящи се батерии. Свързващите клеми не трябва да бъдат давани на късо.
- CN** 装有不可替换电池的电池驱动玩具。接线端子不准短路!



(D) (A) (CH) (L) (B) Denken Sie an den Schutz der Umwelt !

- Ihr Gerät enthält wertvolle Rohstoffe, die wieder verwertet werden können.
- Geben Sie Ihr Gerät deshalb bitte bei einer Sammelstelle Ihrer Stadt oder Gemeinde ab.

(GB) (M) (IRL) Environment protection first !

- Your appliance contains valuable materials which can be recovered or recycled.
- Leave it at a local civic waste collection point.

(F) (L) (CH) Participons à la protection de l'environnement !

- Votre appareil contient de nombreux matériaux valorisables ou recyclables.
- Confiez celui-ci dans un point de collecte pour que son traitement soit effectué.

(E) ¡¡ Participe en la conservación del medio ambiente !!

- Su electrodoméstico contiene materiales recuperables y/o reciclables.
- Entréguelo al final de su vida útil, en un Centro de Recogida Específico o en uno de nuestros Servicios Oficiales Post Venta donde será tratado de forma adecuada.

(NL) (B) Samen het milieu beschermen !

- Uw product bevat meerdere recycleerbare materialen
- Breng deze naar een afval-inzamelpunt.

(B) Participons à la protection de l'environnement !

- Votre appareil contient de nombreux matériaux valorisables ou recyclables.
- Confiez celui-ci dans un point de collecte ou á défaut dans un centre service agréé pour que son traitement soit effectué.

(I) (CH) Partecipiamo alla protezione dell'ambiente !

- Il vostro apparecchio é composto da diversi materiali che possono essere riciclati.
- Lasciatelo in un punto di raccolta o presso un Centro Assistenza Autorizzato.

(P) Protecção do ambiente em primeiro lugar!

- O seu produto contém materiais que podem ser recuperados ou reciclados.
- Entregue-o num ponto de recolha para possibilitar o seu tratamento.

(DK) Vi skal alle være med til at beskytte miljøet!

- Apparatet indeholder mange materialer, der kan genvindes eller genbruges.
- Bring det til et specialiseret indsamlingssted for genbrug eller et autoriseret serviceværksted, når det ikke skal bruges mere.

(S) (FIN) Var rädd om miljön!

- Din apparat innehåller olika material som kan återanvändas eller återvinnas.
- Lämna den på en återvinningsstation eller på en auktoriserad serviceverkstad för omhändertagande och behandling.

(FIN) Huolehtikaamme ympäristöstä!

- i Laitteesi on varustettu monilla arvokkailla ja kierrätettävillä materiaaleilla.
- Toimita laitteesi keräyspisteeseen tai sellaisen puuttuessa vaikka valtuutettuun huoltokekkukseen, jotta laitteen osat varmasti kierrätetään.

(H) Első a környezetvédelem!

- Az Ön terméke értékes újrahasznosítható anyagokat tartalmaz.
- Kérjük készülékét ne dobja ki, hanem adja le az erre a célra kijelölt gyűjtőhelyen.

(CZ) Podílejme se na ochraně životního prostředí!

- Váš přístroj obsahuje četné zhodnotitelné nebo recyklovatelné materiály.
- Svěřte jej sběrnému místu nebo, neexistuje-li, smluvnímu servisnímu středisku, kde s ním bude naloženo odpovídajícím způsobem.

(SLO) Sodelujmo pri varovanju okolja!

- Vaš aparat vsebuje številne dele, ki imajo svojo vrednost ali jih je še mogoče uporabiti.
- Oddajte ga na mestu za zbiranje odpadkov ali pa na pooblaščenem servisu, da bo šel v predelavo.

(SK) Podieľajme sa na ochrane životného prostredia!

- Váš prístroj obsahuje četné zhodnotiteľné alebo recyklovateľné materiály.
- Zverte ho sbornému miestu alebo, ak neexistuje, zmluvnému servisnému stredisku, kde s ním bude naložené zodpovedajúcim spôsobom.

(PL) Bierzmy czynny udział w ochronie środowiska!

- Twoje urządzenie jest zbudowane z materiałów, które mogą być poddane ponownemu przetwarzaniu lub recyklingowi.
- W tym celu należy je dostarczyć do wyznaczonego punktu zbiórki.

(GR) (CY) Ας συμβάλλουμε κι εμείς στην προστασία του περιβάλλοντος!

- Η συσκευή σας περιέχει πολλά αξιοποιήσιμα ή ανακυκλώσιμα υλικά.
- Παραδώστε την παλιά συσκευή σας σε κέντρο διαλογής ή σε ένα εξουσιοδοτημένο κατάστημα σέρβις.

(RO) Țineți cont de protecția mediului !

- Aparatul dvs. conține materii prime valoroase care pot fi revalorificate.
- Din acest motiv vă rugăm să predați aparatul dvs. la un centru de colectare din orașul sau comuna dvs.

(BG) Мислете за околната среда !

- Вашият уред съдържа ценни суровини, които могат да бъдат рециклирани.
- Затова върнете своя електроуред на специално място за събиране на такива отпадъци във Вашия град или община.